

The Australian Thermalcer

Information, Competition Results and Articles for Australian SAM Chapters and Groups

Issue No.2 Jan - March, 2020



270
WESTERN AUSTRALIA



SAM 1993



SAM 84 Queensland

These drawings are from the July and Sept. issues of the 1934 Model Craftsman magazine, by Edward E. Thorpe and Harold V. Loose. The drawings are full size, if anyone wants printed instructions, please send SASE and \$1.00 to editor.

AERO EN
7/8" BO
5/8" S
6 C.C.
2-CY

SECTIONAL ELEVATION.

PLAN.

SHEET NO
FULL SIZ



**ALICE SPRINGS
Masters Games**

10-17 October 2020

The Friendly Games

<https://www.alicespringsmastersgames.com.au/>



SAM 600 Australia - Victorian Old Timers Association Inc. Committee

 President Kevin Fryer Home: 03 9842 4361 Mobile: 0438 561 440 Email: fryerkd@gmail.com	 Vice President Lyn Clifford Home: 03 5486 2541 Mobile: 0429 165 669 Email: lynclifford@exemail.com.au		
 Secretary/Treasurer Public Officer Brian Dowie Home: 03 9706 2074 Mobile: 0402 918 916 Email: brianclfyro@hotmail.com	 Contest Director Don Grant Home: 03 5623 4966 Mobile: 0419 871 306 Email: drgrant@dcsl.net.au		
 Committee Member Pat Keeley pekeely@live.com	 Newsletter Co-Ordinator Brian Laughton brianlaughton1957@hotmail.com	 Safety Officer Steve Gullock coodgiebear@hotmail.com	 Member Registrar Roger Mitchell 03 5406 4236



"The Thermaleer" is the official newsletter of SAM 600 of Australia, Victorian R/C Old Timers Association (SAM600) Inc.

From the President Kevin Fryer.



The start to the year's competitions, the Roy Robinson Trophy at P& DARCS, was unfortunately cancelled because of the very strong windy weather, blowing at about 35kph. A number of flyers attended the field but just sat around chatting until about 11.30am at which time the contest was called off and everyone went home.

We are progressing well with the height clearances for P&DARCS, Echuca, Cohuna and Mount Wallace. Tyson Dodd has told me that CASA will require some additional information from us. I will make sure that this is done as quickly as possible and I will keep you advised as soon as I get more information.

Peter van de Waterbeemd, President of SAM 1788, is working on setting up a National Special Interest Group for SAM Members. This will allow us to change rules in a democratic manner where every SAM member has an opportunity to vote on any rules or other changes. This system was used to form our current rules and has worked very well.

I am proud to say that my son Chris flew his Speedy electric glider from the Joy Stick on his wheelchair. It has been some 26 years since Chris has been able to fly a model but he has not lost any of his old skills. However there are still a few refinement to be made to the system and Chris and his team are presently busy working on it. Next, Chris will try a take-off. Keep tuned.

Stay well. Kevin Fryer. President SAM 600.

**From The Thermaleer #82 Oct-Nov 2002
Ramblings, by Don Howie.**

Recently took a trip overseas and some of my observations may be of interest to Old Timer flyers here in Oz. Whilst in Germany I visited the Deutsches Museum in Munich which has a quite amazing display of German model aircraft. German model engines from about 1918 are displayed together with the famous American engines from the thirties and the European diesels from about 1939.

German model development is displayed and their history of Radio Control with the Herr Stegmaier model from about 1950 that used pneumatic controls - very advanced at that time. Early German R/C from the late fifties; Grundig, Metz, Telecont, that used tuned filters were also most advanced at that time. Also the development of electric models by Fred Militky.

In England I stayed with David Baker of SAM 1066 and visited Old Warden and Middle Wallop. The cost of old engines at Old Warden was rather out of my reach as it is about 3 dollars to one pound. Free flight in the UK is very popular and many of the spark engines flown without radio control were British, such as the 6cc Stentor from 1947, and other low power models. I enjoyed seeing many of the old Frog kits that I remember as a boy, from rubber to controlline, such as the Radius and Vandiver models.

The SAM Champs at Middle Wallop was huge, the weather was very pleasant and I flew a "Tomboy" with an Indian Mills .75, until I got too tired chasing it for considerable distances. It was very pleasing to talk to many famous modellers, such as Vic Smeed and George Fuller, who actually read my AMI column. George said he hopes to come to Australia next year. Ohil Smith, the Vernon kit designer was interesting, along with Norman Marcus who had some great F/F designs. I must have been lucky in the UK as it did not rain and I actually got sunburnt.

Over to the USA and after a fairly hectic drive from Indianapolis I arrived at a wet Muncie, not quite knowing where I was to stay. I managed to get accommodation at a motel next to the Headquarters Hotel and found that I had Sal Taibi, Larry Jenno and many other top modellers staying at the same motel.

Next morning I drove to the MECA Collecto in the centre of town at the Convention Centre; and this was like heaven seeing all the old engines and bits and pieces for sale. Out the back they were running old

engines, such as the Motton M5 radial 4 stroke, which was very quiet when running. The old Spark engines are now very good value in the USA as many of the old modellers have passed away and their collections are for sale. The perfect or as-new engines are expensive; but marked or slightly rough engines are at giveaway prices.

The AMA 1,000 acre flying site was amazing with bitumen roads going to the different areas and camping facilities on the site. The weather was a bit windy at times for the F/F flyers, but the highlight was the AMA Museum that I spent days going through, as it was so interesting.

They even have a lounge with armchairs with bound folders of all the old US magazines; you get out any magazine you require and can photocopy any article in the copying room. A truly amazing place, the Headquarters, that employs 50 people full time.



SAM Champs, Muncie, USA, August 2002
Don Howie holding the Brogini "Stardust Special" owned by John Hatch of Canada. Long wing version, 585 in² wing, PAW .19 diesel for A Texaco. 11x4 Topflight power point prop, Profilm (Oracover). In front of R/C area. Bitumen roads & surfaces contest sites.



REGISTER NOW AND FLY WITH YOUR MATES FOR THE WEST WYALONG NATIONAL CHAMPIONSHIPS

Fly sky high with your mates and be part of Australia's 1st West Wyalong National Championships - a renowned model aircraft show held on July 7-15, 2020.

In an exciting first for the sport of aeromodelling, the National Championships will be hosted by the NSW Free Flight Society in conjunction with Control Line Aircraft Society NSW (CLAS).

This year's event promises to offer an aerial spectacular for the whole family to enjoy and will be one of the most comprehensive model aircraft shows in Australia.

Why you should attend

From aerobatics to graceful gliders, replica scale models to exciting control line combat, the event will showcase the very best of our sport and cater for novice flyers through to the most experienced pilots.

The 2020 West Wyalong National Championships present a rare, eye-opening opportunity for all MAAA members to witness events from different disciplines and gain an insight into other modelling events.

It will be a memorable and enjoyable event filled with great competition, thrills and camaraderie.

When and Where

The West Wyalong National Championships are an 8-day event that will take place



across five conveniently close sites all within 15 minutes of West Wyalong during the week of July 7-15, 2020.

Share the thrill of our sport and bring your families along to enjoy one or perhaps several spectacular days out. See the program on the next page.



Ways you can register

Be part of the fun, thrills and camaraderie the West Wyalong National Championships will offer to all competing pilots. Complete the online registration form by 25th May - See link below.

An administration fee is required by all entrants whether they are flying socially or for competition. The fee covers a host of charges; the venues where you fly; the toilets supplied on the field; shade shelters; medical kits; safety vests; communication equipment in case of emergency aircraft landings; height permission clearances and many other important items plus your goodies bag.

Be part of the fun

West Wyalong National Championships will undoubtedly be a memorable and enjoyable event filled with great competition and camaraderie.

Take a look at our program (next page) or register to fly at the West Wyalong National Championships on link below. You don't want to miss it.

I encourage all MAAA members to participate. For more information click on link below.

Neil Tank

**Neil Tank
President**



Information: <https://www.maaevents.com.au/>

Register by 25th May, 2020: <https://www.maaevents.com.au/about/register>



Activity & Date	Social Events	Stadium FF/RC indoor	CL Aerobatic McAllister	CL Speed AB Hardstand	Q Combat and Racing Perseverance	FF AB Field	SAMs AB Field	EOT AB Field	F5J, F5B AB Field
Tue 7			Demo Fun Fly/try day/Prac	Practice	Practice	Practice & fun fly every day - see CD each day	Practice	Practice	
Wed 8			9am-4pm F2B Rd 1 AEROBATICS Adv and Exp	9am-1pm Combined/Jet Speed 1pm Junior 2.5cc Rat Race	10am-5pm F2d	Practice & fun fly every day - see CD each day	Practice	Practice	
Thu 9			9am-4pm F2B Rd 2 AEROBATICS Adv & Exp	9am-1pm F2C T/RACE Heats 1&2 1pm Classic FAI T/R	8am-5pm 1/2A Combat	8am-2pm P30, F1J, Vintage Rubber Vintage Glider	9am-1pm 2cc Duration 1pm-5pm Standard Duration	EOT events Timings per organiser	
Fri 10			9am-4pm F2B Rd 3 AEROBATICS Adv & Exp	11am-2pm F2C T/Race Heats 3&4 F2C Finals 2pm F2F T/Race	8am-10.30am Slow Combat 2.5 Vintage A T/R	8am-2pm F1B, Open Power Fly off 4.30 pm	9.30am-10am Sport/Cabin SCRAMBLE 1pm-5pm Vintage Glider	EOT Events timings per organiser	F5J Practice in conjunction with EOT
Sat 11	7.00 PM Country Lamb Roast dinner, wine and Camp fire		9am-4pm F2B Rd 4 AEROBATICS Adv & Exp	11.30am-5pm Open R/ Race, SNR 2.5cc R/Race	9am-11am CLASSIC B Team racing	8am - 2 pm F1A, F1C Flyoffs 4.30 6.00-7.00pm Night Scramble 7.00 PM Country BBQ	9am-1pm 1/2A Texaco 1pm - 5 pm Duration	Reserve	F5J
Sun 12	Swap Meet 6-9pm at Indoor Stadium	10.00am-3.00pm Practice and fun fly. 3pm-6pm Peanut static Judging. Swap meet 6-9pm	Classic Stunt	9am-11am Round 1&2 F2A SPEED GOODYEAR.	TBA	8am-9am Day Scramble 9 am - 12.30 pm Combined HLG, CLG & DLG 9am - 2 pm E36	9am-1pm Gordon Burford 1pm-5pm Texaco		F5J
Mon 13		9am-4pm Practice and fun fly. 4pm-9pm HLG, F1H, Peanut	Vintage Stunt	9am-11am Round 3&4 F2A SPEED 11am GOODYEAR 27sec/10 laps	8am-5pm OPEN COMBAT	8am-2pm 1960's Coupe Vintage power F4A	1pm-5pm Nostalgia		F5B
Tue 14		9am-4pm Practice and fun fly. 4pm-9pm Open scale, Kit scale H/Rar, H/Rat scramble	F4B	Reserve Day	8am - 5 pm VINTAGE COMBAT	F1H, F1G, OZ Diesel	9am-10pm 38 Antique. Afternoon reserved for any cancelled event		F5B
Wed 15		Closed	Reserve	Reserve	Closed	Reserve	Reserve		Res



FOR OLD TIMER'S SAKE. By Don Howie.

This article is mainly about model engines, but I thought I might mention the "Scarlet Tanager" at 48 inch span that I re-built some time ago.

The original was based on the Hall Racer and kitted by Geo. D. Wanner & Co., Dayton, Ohio, USA, in 1934. It was a rubber model at 24 inch span and quite difficult to build, so doubt it was very popular.

In February 1938, it was re-drawn at 48 inch span, now as a gas or rubber model by Ned Gallagher of the Ace Model Aircraft Institute. It had light-weight construction as it was powered with a Corncobb Elf engine, that ran about 3,000 revs. The model shown was built by Jack Simmons of the Willunga Vintage Modellers Club, as I had loaned him the plan.

The model crashed on the first flight and I decided to re-build the model (now electric powered). making it stronger without adding much weight. When flown by Don Howie, the wings built as original lacked strong enough spars, so these were re-enforced with carbon fibre lengths. Jack Simmons bought the model back and has recovered the wings and improved the finish on the model. The model is currently now flown by Jack.

Ivan Stacey recently had to give away model flying, age and health reasons, so sold his collection of models. I bought his 50% "Dallaire Sportster" at 52 inch span, kitted in OZ by Old Fashioned Hobbies about 25 years ago.

The model was powered with an O.S. Max FP10 glow engine for 2cc competition. A friend was interested in using this engine so it was sold to him. Small electric motors are quite low cost, I think the A2212/13T at 1,000 KVA was about \$7.00 from Banggood and they work well on 3 cells. I managed to buy a 30amp speed controller (new) for \$5.00 at the Holdfast Sidewalk Sale, and this is the reason most of my new models have electric power. The Dallaire is a bit rough and needs a new front windscreen, and I am currently making a front balsa cowl.

GEE BEE 2nd MODEL

This diesel engine, by Gordon Burford, at 0.325 cu. Inch (5.3cc) was made in 1948 and based on the first U.S. Drone model. Many were exported to the USA to be exchanged for Arden .199 spark/glo engines and Wally Reeves obtained an Arden 19 in 1948 by this method, as U.S. engines were not obtainable in Australia at this time.

Maris had to make a new piston, contra piston, needle assembly etc. after getting the taper on the bore fixed by Geoff Potter. The engine is shown running on a 12x6 SUPER THRUST wood prop, running at 6,200 revs. This is equal to a Drone plain bearing model.



1948 GEE BEE 5.3cc Diesel running at home of Maris Dislers.

1954 McCOY .049 DIESEL.

In my last F.O.T.S. article I mentioned the McCoy .049 POPPET VALVE glo engines produced in the nineteen fifties. I received a McCoy .049 diesel, 1954 poppet valve engine as a Christmas present and Maris Dislers was interested to test this engine that had great compression and was in like new condition.

Maris has vast experience with model diesels, his engine tests in Aero Modeller magazine are far more complete than any other writer, past or present. It is interesting that Maris uses different diesel fuel mixes, as the old diesels do not need ignition improver when running below 10,000 rpm.

A lot of the early diesels like thick mineral oil rather than castor oil in the mix. Maris also uses JET A kerosene for more power, rather than lighting kerosene, obtainable in plastic bottles, used by most modellers.

The McCoy took a short time to get started on a 7x4 Taipan prop, but fur-



Don Howie holds 48 inch span Scarlet Tanager, 1938 Plan. Electric Powered 8x6, electric prop, 2 cells 1500 mah 2S.



Close up of 48 inch "Scarlet Tanager" (American Songbird)



Front of electric converted 50% Dallaire Sportster. 1936 design by Frank Dallaire at 104 inch span. Model was kitted. Flown in Texaco at 1936 US Nationals.

ther starts were quite easy once the settings were obtained.

RESULTS ON DIFFERENT PROPS: 8x4 APC - 7,000 rpm, 7x5 APC - 8,800 rpm, 7x4 APC - 9,700 rpm, 7x4 Taipan - 10,000 rpm, 7x3 APC - 11,800 rpm, 6x4 APC - 13.300 rpm, 6x3 Cox Grey - 14,200 rpm.

The maximum power was between 11,000 and 13,000 revs, and Maris suggests a 7x3 APC or Master Airscrew for best performance, along with a 6x4 for full power.

The McCoy .049 is quite high revving, but the OK .049 diesel has more power at lower revs. The "O" ring in the contra piston did not give any problems. The poppet valve gives the engine quite a good rev range, but not so good at the higher revs.

SAITO ENGINE HISTORY.

This company in Japan, started by Gen Saito in 1959, makes only four-stroke model engines that I like very much. The first engines from 1959 were steam engines that needed a boiler and many were made for model boat use.

I noticed recently, on line, a Saito V4 of 2.5cc capacity steam engine for model boats up to a metre in length, that I suspect was made in the nineteen sixties. One of the agents for their steam engines was Aeronaut in Germany, who, in the nineteen seventies, suggested they produce model I.C. engines.



SAITO G 60 F two-stroke, spark engine. Released 1975 with coil, muffer etc. Also came as rear-induction version. Below: The other side. Has markings for start/run arm position on spark timer.



In 1975, Gen Saito produced a 10cc two-stroke spark engine in aircraft and marine versions. The big sales point was low cost fuel and good economy using a 10 to 1 mix of petrol and Yamaha two-stroke oil. It came with a 4.8 volt to 6 volt coil, using a receiver pack (4.8 volt nicads) or 4 AA dry cells. This would give three hours continuous running in a 60 size aerobatic model, turning a 12x6 prop at 10,000 revs.

The engine used a low cost 10 mm N.G.K. CM6 spark plug. The photo shows the G 60 F model owned by Bill Britcher, with coil, condenser (bottom), high-tension lead, wiring and 10K resistor for the high-tension lead. The engine could also be obtained as a rear-induction model for the same cost of US\$149.99, sold by Hobby Shack in the USA at the time.

The sand-cast engine with spark timer was quite heavy for aircraft use, so the muffer was made from very thin material to reduce overall weight. This engine was available up to 1981 and suspect sales were quite low.

In 1979, Gen Saito decided to produce a small four-stroke glo engine for model aircraft. This engine was the open-rocker, 4 bolt head F.A. 30 (5cc) Saito shown in the photo. It proved to be very popular and larger four-stroke engines followed. By 1981 Saito now employed 30 workers, only making four-stroke model engines.

Also shown is the later F.A. 30 (5cc) engine fitted to my 75% Dallaire Sportster. The feature of Saito four-stroke engines is the hemi head that gives great running and does not backfire, throwing off the prop nut.

Note this engine does not need a double prop nut. Regards, Don Howie.



First SAITO F.A. 30 four-stroke engine, 1979, owned by Bill Britcher. At Right: Recent SAITO F.A. 30 (5cc). Great running engine. 11x4 nylon prop.



1954 McCoy .049 Diesel with Poppet Valve.



McCoy .049 Diesel with Poppet Valve running nicely.



A 30" WINGSPAN, SPORT FREE FLIGHT MODEL

CHERUB
Designed by
V.E.SMEED 4/6
Copyright of
The Aeromodeller Plans Service
24 CLARENDON RD. WATFORD Herts.
ALL WOODS UNLESS OTHERWISE STATED ARE BALSA

DATA	
SPAN 30"	WING AREA 153 SQ. INS.
TAIL AREA 50 SQ. INS.	LENGTH 21-5/8"
WEIGHT 7-1/2 OZS.	WING LOADING 7.0 OZS/SQ. FT.
POWER ANY 0.5 TO 1 C.C DIESEL UP TO 0.049 GLOW	

MATERIALS REQUIRED	
2 OFF 1/16" x 3" x 36" SOFT	12" x 1/4" x 3" VERY SOFT
1 OFF 2/16" x 2/16" x 2" MED.	12" x 1/4" x 3/8" BEECH BEARERS
1 OFF 1/8" x 3/8" x 36" MED.	6" x 1/8" DOWEL
1 OFF 1/8" x 3/4" x 36" T.E. MED. SOFT	14 SWG PLAIN WIRE
1 OFF 1/2" x 1/8" x 18" T.E. MED. SOFT	SCRAP 3/16", 3/32", 1/32" SHEET, 1/16" PLY
1 OFF 1/8" x 3/16" x 36" MED	CELLULOSE, TISSUE, WHEELS ETC.

Increasing popularity of the .5 c.c. motors creates a demand for small power models which, until fresh contests are arranged for baby motors, are generally required to be of the semi-scale, pleasure-flying type.

"Cherub" has been designed with this end in view, but, in having in its 30 in. wing, 153 sq. in. of area, it is also quite capable of handling any motor of up to 1 c.c.

All flying with the prototype has been carried out with a better than average Mills 75, using an 8x4 plastic propeller, which gives a rate of climb in the order of 800 feet per minute, without

Introducing any trimming complications whatsoever.

Features of the design are the rugged but simple construction, low cost, and short building time. The all-sheet

fuselage takes less than half the time of a built-up job, and that bugbear of most modellers, the cowling, has been reduced to five pieces of very soft 1/4in. sheet. Wing and tail each involve only one rib size and easy sheet tips, so that even a slow builder should be able to complete the whole model in about ten hours building time,

No trimming whatsoever-not ever rudder- was needed on the prototype for safe flying.

Check that the model balances 2 in. back from the leading edge (i.e., just forward of mid-chord) try one hand glide,



then launch with everything straight and the motor running slowly, use a Truflex 8x4 for initial tests with motors of .75 or above. Progressively increase motor speeds and make any small adjustments that may be desirable.

Probably slight right rudder will be advisable for the best flight pattern, but "Cherub" will turn either way without danger.

Detailed building instructions are issued free with each copy of the full size plan

from the Aeromodeller Plans Service. We can recommend this design to beginners, for its easy to build, easy to fly characteristics, so if you are contemplating a point five engine, this is your plan.

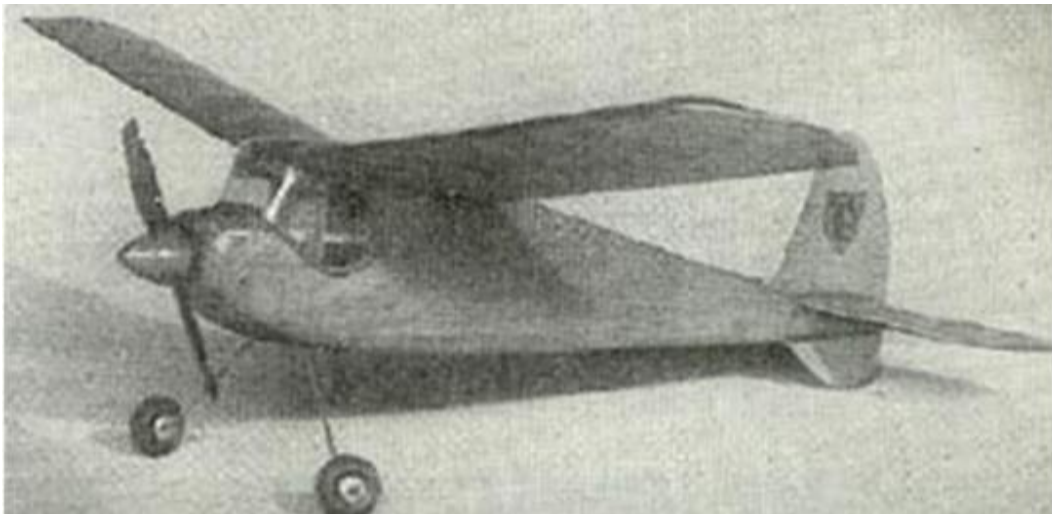

From Bruce Ramsay auscanav@bigpond.com

Hello,

Well done with the Thermaleer gone national. A little item for next issue.

My partner Diana brought some shower caps at Cheap as Chips or similar for about \$4.

The length of the hoops is 91cm and there are three in a pack. Equals nearly 3 m.

Nice, firm and very light nylon tube. Very suitable for closed loop flight controls we use in old timers.

Cheers, Bruce.

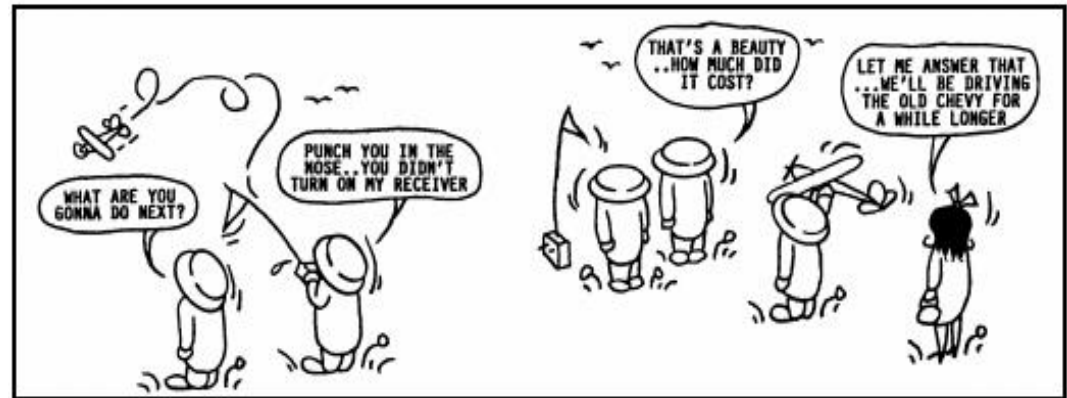



Duration Times is the official Bulletin of SAM 1788
SOCIETY OF ANTIQUE MODELLERS OF AUSTRALIA INCORPORATED

SAM 1788 Executive 2019-2020

President:	Peter van de Waterbeemd	35 Cosham Close, Eden, NSW 2551.	02 6496 4769
Vice President:	Peter Scott	44 Ravel Street, Seven Hills, NSW 2348.	02 9624 1262
Secretary:			
Treasurer:	Paul Farthing "Bogwood",	55 Lockwood Rd, Canowindra, NSW 2804.	02 6364 0264
Committee:	Jim Roe 02 6495 3530, Basil Healy 02 6651 6563, Anthony Vicary 0458 723 073		
	Email for Australian Thermaleer - waterbee@bigpond.com		

Old Timer Flyers - 38th SAM Champs Postponed.

It is with great reluctance that I advise you that, due to the Corona virus, the committee has decided to postpone the 38th SAM1788 Championships until spring 2020.

This decision has not been made lightly and is in line with the best advice that can be garnered from official websites and from guidance given by authorities.

The Corona virus epidemic is ramping up at this stage, and what the status will be in three weeks time when the Championships were to start, is anybody's guess.

This decision was made with an abundance of caution and the committee had the best interest of all competitors in mind. The age demographic for our Old Timer group puts us at very high risk. The committee's duty of care was very clear. We personally also owe that duty of care to everyone of our fellow modellers.

It is hoped that bookings can be cancelled and fees refunded. This early warning should see most competitors avoid an unnecessary trip. Sorry to Les Morris who has come from Innisfail, FNQ, and is currently touring somewhere in Victoria.

I am aware that SAM1788 has its AGM at the Championships but we will apply for an extension of time from the Office of Fair Trading so that the AGM can be held at the Championships in spring.

For those competitors who have already paid their entry fees, these will be refunded or optionally retained until the Championships in spring. Please advise the Treasurer, Paul Farthing, what you wish to do.

At this stage the New England Gas Championships, scheduled for 13-14 June, are also likely to be postponed or cancelled.

I trust that we will all see each other again at the next competition.

In the meantime, follow all the guidelines and keep safe.

Peter van de Waterbeemd
 President SAM1788



SAM 1788 President's Report

The first event of the year was the annual pilgrimage to Orange. The event was not overly well supported due to the predicted high winds and temperature as well as other factors such as the bush fires. There are some reports and photos on this event elsewhere in this issue.

Our next event was to have been the 38th SAM1788 Championships at Easter at Canowindra. Due to the Coronavirus, the Championships have been postponed until Spring 2020. The decision was made in the interest of all Old Timer flyers, the majority of whom are in the high risk age category.

Unfortunately, opinion has been expressed that we may not see any more competitions this year. Opinions vary as to whether this epidemic will last six months or even 18 months by which time a vaccine may have been developed, tested and widely available. See a more detailed statement elsewhere in this newsletter.

I am in the process of creating an Old Timer National Special Interest Group, an NSIG which has direct input into the MAAA. The major role of this NSIG will be to advise the MAAA on rule changes relating to the MAAA Section 5 rules. There are other published functions of an NSIG but most of these do not apply as there are no International Old Timers events.

As all modellers are well aware, there is a 400' AGL height limit for RC and FF model aircraft. This limit can be varied for selected sites via an application to CASA and to date this is generally, but not always, up to 2000' AGL. These limits are like vehicular speed limits, the law of the land. Time was to have been set aside at the AGM at Easter to allow for comments from Old Timer flyers on how the height limits can be adhered to. This discussion will now be postponed until the spring meeting.

I trust I will see you all at our next competition. In the meantime keep safe!

Peter van de Waterbeemd. President SAM1788.

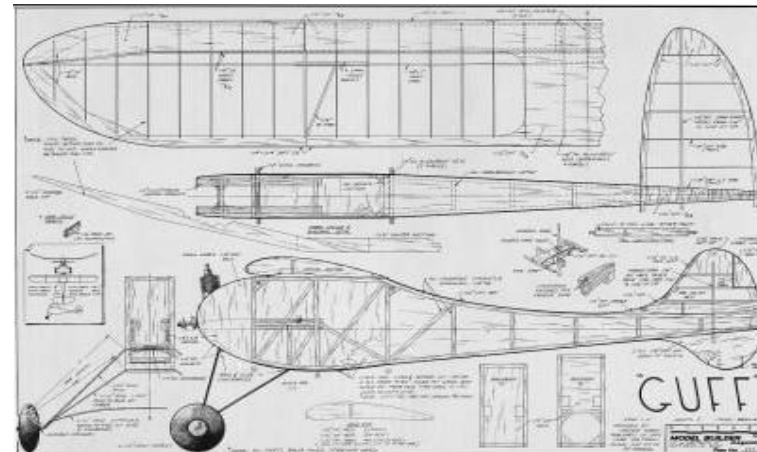

The "Guff" by Walter Good.

Designed in 1938 by Walter Good and published in the June 1940 Issue of Air Trails magazine. Guff is an Antique model of 72" span with a Grant type airfoil section.

"Guff" was kitted by Midwest Model Aircraft Corporation. A subsequent variation of the original was designed especially for radio control, it was called, naturally, the "RC Guff".

SAM1788 Competition Calendar for 2020

- June 13-14** **New England Gas Championships - Tamworth**
Events:
 Saturday: Gordon Burford, Standard Duration, Duration
 Sunday: Cabin Scramble, 1/2A Texaco, Texaco
 Contact Person: Gary Whitten 0428 620 358
- July 7-15** **The First West Wyalong National Championships - West Wyalong**
Events:
 All 9 MAAA Old Timer Events plus other MAAA modelling disciplines
 Contact Person: Peter Scott 02 9624 1262
 See Official Program for details
- August 28-30** **Cowra Oily Hand 2019 - Cowra**
Events:
 Various events plus SAM1788 Cabin Scramble
 Contact Person: Andy Lockett 02 63423054
- September 4-6** **Coota Cup Old Timer Weekend - Cootamundra**
Events:
 Friday pm: Old Timer Glider
 Saturday: Gordon Burford, Antique '38, Duration
 Sunday: Cabin Scramble, 1/2A Texaco, Texaco
 Contact Person: Peter Scott 02 9624 1262
- November 14-15** **Golden West Old Timer Weekend - Parkes**
Events:
 Saturday: 2cc Duration, Gordon Burford, Duration
 Sunday: Cabin Scramble, 1/2A Texaco, Texaco
 Contact Person: Paul Farthing 0427 640 264

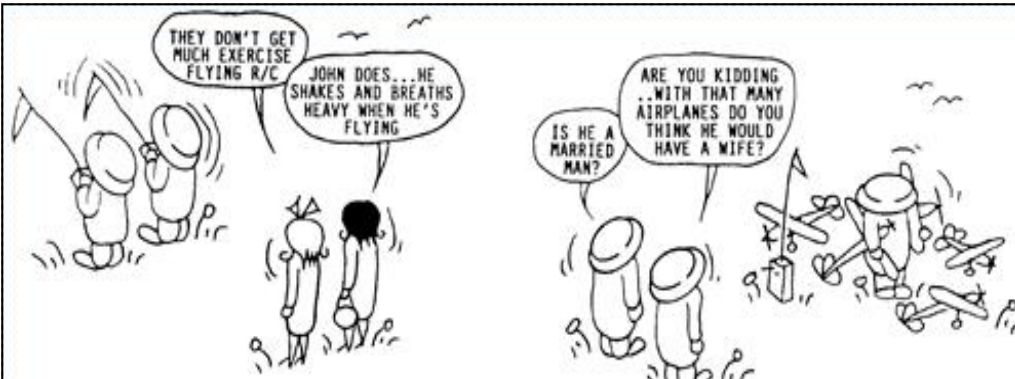
**REPORT ON SPEKTRUM AR6610T** From Peter van de Waterbeemd

I have trialled the new Spektrum AR6610T receiver with excellent results.

This is a six channel receiver which incorporates telemetry and all incorporated in the one small package. It is effectively a six channel receiver as well as a telemetry transmitter. There is built-in Variometer and an Altimeter as well as ports for a satellite receiver, voltage (for a battery pack not connected to the receiver such as pack used for an outrunner) and an XBUS port. The receiver has two quite long antenna which presumably are used in reception and transmission.

I used it in conjunction with a Spektrum DX8 Gen 2 transmitter with the latest firmware upgrades installed.

I installed the receiver in my Pacific Ace and tested three features which are of interest to Old Timer flyers. This was the variometer, the altimeter and an audible warning on the transmitter that a specified height had been exceeded by the model. All worked very well.

The first was the variometer whereby the transmitter sounded a rising tone when the model was climbing and a decreasing tone when the model was descending. This function is of course not allowed when flying an old timer model at our events. This feature can be turned off.

The second feature was the altimeter. This is a feature where a female voice on the transmitter reports the model's height above AGL. Again, this function is not allowed when flying an old timer model at our events and again this feature can be turned off.

The third feature is a warning from the transmitter when the model exceeds a user set height. In the test, this was set to 1950 feet AGL. When the model reached this height, the transmitter sounded a very loud continuous warning until the model descended below 1950 feet. When the height was breached again some time later the warning was sounded again. It is possible that this function may not be allowed under the current rules but the feature is of no advantage to the pilot as it results in the pilot flying the model down to a lower height. This however does meet the requirement not to exceed the height limit (2000" AGL on most of our fields) either during the climb out or during the subsequent glide phase.

Section 5.4.1.5 (q) of the R/C Old Timer Rules 2017 states "Thermal indicating devices are not permitted in R/C Assist Old Timer events." The warning feature is not indicating a thermal but rather that the model needs to descend below a set height limit. It could be argued that if the model again, or repeatedly, exceeded the specified height, then this indicates thermal activity. However it also indicates a requirement to fly lower. Does the CD know that the height limit is appropriately set in the TX? Probably not, but I have the knowledge that the model is flying within CASA regulations.

The retail price for this receiver is around \$120. Safe flying, Peter van de Waterbeemd.





Control Line Racing at SAM1788 Championships

Control Line Racing at the upcoming Championships will be run on Thursday morning from 9am to 12 noon in its own exclusive time slot.

The new classes and engine rules which now apply at the Championships are detailed below:

Keil Kraft Phantom: Two Classes:

Class 1 – Side port Diesels up to 2cc as per the current Class 1 rules.

Class 2 – Any production plain bearing Australian or British diesel, up to 1.5cc.

Any plain bearing Taipan/Burford engine up to 1.5cc produced before 31/12/1970.

British Engines: Frog 1.5/1.4cc; Elfin 1.49cc; AM15; ED Hornet, Allbon Javelin; DC Sabre; ME Scribe or any other British engine produced before 1970 and approved by the SAM 1788 committee.

The old Phantom Class 3 and Class 4 were phased out in 2019.

Note that it is a requirement for Phantom models that the engine is securely tethered to the belcrank with steel wire.

Keil Kraft Champ: Two Classes:

Class 1 – Any Australian or British engine, or replica thereof, up to 0.8cc produced before 31/12/1970. The MP Jet .6cc is included for historical reasons.

Class 2 – Any Australian or British engine, or replica thereof, up to 1.0cc produced before 31/12/1970.



Spark Without (too many) Tears. From Peter Scott.

It never fails to surprise me how people have troubles getting sparkies to go at a contest. Quite often the causes are simple, and if the system on the model has worked well previously, then the problem is usually that the presumption that it was okay last time so it must be this time, is not true.

The model and fuel systems should be cleaned out properly after the last outing. This still leaves the fuel system with old oil in the tank and lines, also old oil and fuel sit in the motor - in all the nooks and crannies. Then you come along and put fresh fuel in and spin it over. All the old oil and 'snot' are then blown onto the plug via the transfer port.

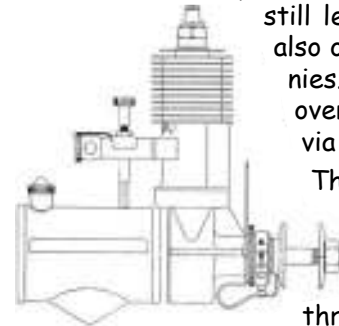

The time taken to get the motor going in this situation usually takes the edge off the battery voltage, which doesn't help.

So, how to make things easier? On the fuel side: flush through the system, remove the needle valve and blow fuel from the tank through the spray bar, until it comes out as a clear stream. Remove the spark plug. Wash and clean ceramic centre - should be white, if it's black, then the carbon will short-out the spark. Set the gap, make sure points are clean. Check they are opening and closing with a meter, then squirt some fuel into the motor, via ports and intake, then spin it over with a starter until all fuel is ejected. With an old, clean plug, with the outer electrode taken off or opened right out, turn over the motor by hand, and with ignition on the spark should jump that gap easily.

The battery voltage to the coil should be 3v. For a really good spark, a 1s lipo is really good or 3 nimh cells are fine. People do use 2 nimh cells and they are happy with that - as they say, whatever works for you - but 3v on most model coils is best.

The use of methanol fuel makes things a lot easier - not for Texaco obviously! But methanol motors run a wider range of needle adjustments, whereas petrol can be rich or lean in just a couple of clicks of the needle. If an engine is running methanol and doesn't fire up immediately, then fitting a glo plug will start the motor and allow you to set the settings correctly - or nearly so - and unflood and clean out the motor. Fit a clean sparkplug and you're away.



Back in the 'good old days' most spark ignition models had a power jack, so, on starting, an external battery took all the load on the coil primary. I always put these on my models and don't use an external battery but one can plug a battery checker in and you will then know the amount of life in your battery. It's a lot easier than just hoping that it's okay.

Preparation is important, don't just turn up to a contest, have trouble and want everyone to help you. They have their own problems to sort out. It is very satisfying to fly old spark motors in old style models, after all - we are the Society of Antique Modelers. Keep sparking, Peter Scott.

Orange Old Timer Weekend 1-2 February 2020

Report from Peter and Gail Scott. Photos Karen Paton. Results Dave Brown.

Well, the weather forecast was for hot and windy with possible late storms. They got it pretty right!

The Scotts had to deliver a motorcycle to Parkes, so it was an early start with a much needed lunch break at chez Smith. It happened to be Peter's 75th Birthday and May produced a chocolate cake.

Sonya was just letting Basil and Jim into our apartment when we arrived in Orange. That was well timed. That evening a delicious meal, cooked by Sonya and Janelle, and a birthday cake led to a terrific social evening at Hagarty's home.

Saturday morning was warm and windy for Nostalgia. Four fliers braved the elements and it turned into a good contest. Basil Healy flew his Sunstreak into first place, only a little in front of Jim Rae's fast climbing Mercury Teal. Jim always seems to find something different! Condo flew his Swayback into Third place. Peter Scott was not far behind with a Dream Weaver - but only flew two rounds due to servo problems.

We had a long social lunch, put on by the Orange club, but only a couple of fliers were keen to fly Duration as it was, by then, very hot and windy. We put off Dura-



The Gang's all here! Back Row L-R Anthony Vickary, Dave Brown, Dave Paton, May Smith, Peter (Condo) Smith, Basil Healy, Jim Rae, Gail Scott, Peter Scott, Front Row L-R Joanne Vickary, Paul Farthing, Bill East, Steve White.

tion until Sunday, after the other contests, weather and enthusiasm permitting.

Saturday evening we had a great evening at the Bowling Club. A smorgasbord of Chinese, Aussie and seafood followed by a good selection of desserts and ice cream.

Sunday morning, at 8am, we flew the scramble. Weather was breezy but fine. Only three flew, with no problems. The scores were very close. Anthony Vickery won, deservedly, as he ran to pick-up his model each time, whilst Jim and Peter settled for a brisk walk. Anthony flew the ever faithful Tomboy, I think it used an MP jet motor. Jim had a redfin motor, and his model travelled at great speed and covered huge areas of sky. Peter used a Veron Deacon with a frog 100 which seems to be very well behaved.

I tried to drum up interest in a ½A event but as the wind got up, and people's courage faltered, we cancelled this event.

After another tasty, and extended, lunch, Texaco flew on schedule. Weather and wind changing all the time. Stormy clouds sometimes gave us a quick shower but the comp went on. Only two reached the fly-off. Very dark clouds approaching with the threat of a storm. The decision was to press-on quickly. Anthony Vickery came out on top with 816 seconds over Dave Paton with 751 seconds. Peter Scott was third with Jim Rae fourth. Brownly had spark problems after his first round and had to pull out.

We had barely put things away and retired to the club house for presentations, when a spectacular storm hit us. Lashings of heavy rain and terrific winds made it



The rain put Brownly out in Texaco. Below: When it's too windy to fly.



hard to hear ourselves speak.

(No one had wanted to fly Duration in the storm!).

A big thank you to the Orange club for putting on the event. Next year it will be run one week later.

Thanks go to the Hagarty family for hospitality in spades and also to the fliers who made the effort. Was it worth it? Yes, it was a great weekend. Plenty of time for socialising, a bit of interesting flying, and we got through half the calendar. Regards, Peter Scott,



**RESULTS Orange Old Timer Weekend
1-2 February 2020**

Nostalgia

Basil HEALY	Sunstreak	K&B 40	694
Jim RAE	Mercury Teal	K&B 40	684
Peter J. SMITH	Swayback	K&B 40	673
Peter SCOTT	Dreamweaver	K&B 40	648

Cabin Scramble

Anthony VICARY		1366
Peter SCOTT	Mills .75	1193
Jim RAE	Mills .75	1108

Texaco

Anthony VICARY	Bomber	O.S. 61 4/	1200	816
Dave PATON	Bomber	Saito 56 4/	1200	751
Peter SCOTT	Bomber 85%	Olsen 60 spk		1184
Jim RAE	Airborne	O5 60 4/		1149
Dave BROWN	Flamingo	O&R 60		600



Photos from the Nostalgia event.

Paul Farthing was there but did not fly.

It was very windy.





Nostalgia:
3rd Condo
1st Basil Healy
2nd Jim Rae.



Texaco flown after the Cabin Scramble on Sunday.

Just managed to get Texaco, flown through some rain showers, but managed to get finished just before the really big storm arrived.





Texaco winners, L to R, Anthony Vickary 1st, Peter Scott 3rd, Dave Paton (Qld) 2nd. Norm Barnes presents Anthony with the Alan Brown Perpetual Memorial Texaco Shield.



Orange Jottings (that's NSW not navel)

Feb 1 & 2, 2020 by Jim Rae.

Despite the weather forecast which was for hot windy weather on Saturday, slightly improved on Sunday with possible showers in the afternoon, a total of seven fliers were there to contest some of the events. Vince Hagarty, with Sonia, was also there but not flying as he had been testing the ability of his drop saw to cut flesh and he found that his thumbnail didn't stop it either. The stitches were to come out the following Tuesday.

Saturday morning a start was made with Nostalgia, with rising wind through the rounds and a result was declared after three rounds, two to count. The weather did not improve and there was no flying for the rest of the day.

Sunday morning, really early, 8.00am, the Scramble was flown. It was still quite windy, I had the wing come off when I was blown over in the stubble, but generally the little models handled it OK. Some of the retrieves were long as it was difficult to judge the landing.

After the Scramble the wind continued to rise and no-one felt like risking their 1/2A models, which would have had difficulty making headway in the wind, so there was no more flying until after lunch when Texaco was held. Late in the morning and over lunch the wind had been moderating so flying conditions at the start of Texaco were not too bad. Into Round Two the rain that had been forecast arrived in the form of storm showers and the rest of the event was flown in the breaks between showers.

Very unusually, Dave Brown, after maxing Round One could not get his engine running. From what I could hear it was not even attempting to fire. Condo Smith also had sparkie trouble. His would give a short burst sounding all right but then it refused to keep running. He did not fly. The event was declared after three rounds, two to count, and a fly-off was required. The wind had been rising with gusts up and over 30kph, however Dave Paton and Anthony Vicary decided they wanted to fly the fly-off so they did, and both survived. Very shortly after they landed the heavens opened and we had a downpour with lightning.

As an indication of the wind speed, I was coming in to land at the end of my third flight while Anthony and Dave were setting up for the fly-off. I turned into wind at a height of about eight metres and about twenty-five metres downwind thinking I would land close to my feet. By the time it was on the ground it was about a hundred and twenty metres downwind. Wind was fairly (!) strong.

Considering the wind which was generally well outside prescribed limits for the whole weekend it is surprising that not one model was damaged during flying.

The only blood letting of the weekend occurred when Peter Scott managed to put his thumb through the tip of the prop. He had started the engine, an O&R 60 I believe, with his starter box and had the transmitter sitting on the top of the box. It started to slide down towards the running engine so he reached up to stop it, just catching his thumb in the tip of the prop. The lacerations were only shallow and the prop was undamaged.

As is usual at Orange the hospitality and catering by the Orange Club was excellent. We may have not done a great deal of flying but that was made up for by lots of socializing. Cheers, Jim Rae.

From John Quigley. flyingnut@tech2u.com.au

Re SAM 26 Newsletter #347

I have just finished reading the above news letter and there is an item about DEANS connectors, "How to make them easy to disconnect by putting Vaseline on the contacts."

My industry experience based on practice is that this will cause problems.

When I was a lift mechanic a fellow mechanic had the idea that if he put Vaseline on the door lock switches it would make the contacts quiet when the doors shut. And it worked BUT.

This was all well and good until some dust got on the contacts and then the lift stopped. The contacts were self cleaning but insufficient wipe in this case.

I was the first to discover this and we had a frantic job to clean door locks around Sydney and the metro area. Trying to find who was doing this, without him feeling he would be sacked, was difficult. There was a toxic culture in those days.

Before I got into electric models a bloke in Maitland had the idea if a 1/16" hole was drilled in the M & F Deans connector then a pair of circlip pliers can be used to split the Deans connector. Very simple.

The DEANS connectors, having exposed pins, is not a good idea but uses a good plastic while the yellow XT60 is a good design made with a low temperature nylon. It is very easy to melt the nylon while getting a good solder joint. It is important to have the end of the wire solid with solder when soldering to the connector. I am yet to try the Black XT60.

Interestingly, the basic design of the XT60, having recessed male pins, is how industrial extension leads are made. These can be 3 phase 300Amp and never soldered, always crimped. Once connected to a cable I could only pick up the plug and put it on a pallet. Two blokes could then wrap the cable on to the pallet, etc.

Soldering an ESC can be difficult due to the RoS requirement. An RoS requirement means that all solder is lead-free. The few ESCs I have soldered I have snipped of the pre-tined end. Ensure that enough solder is removed that has flowed up under the insulation.

I would like to see a crimped terminal on these plugs and have discussed this with Tom Prosser. He has done more electric flying than I without any problems but he is an accomplished solderer.

I never liked the Deans power connectors, but back in the days of reed radios we used 8 pin Deans connectors exclusively as they never gave any problems. They were a great design as they were mechanically keyed and the pins could be removed and also electrically keyed. You may have seen these.

Best Regards, John Quigley.



Various connectors referred to by John in his article opposite.

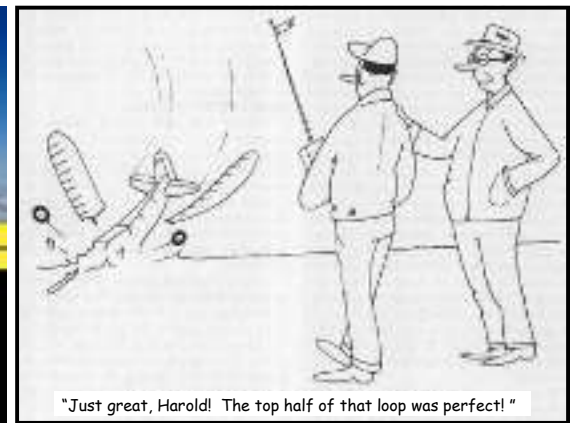

When Love Fades...

Last night I was sitting on the sofa watching TV when I heard my wife's voice from the kitchen. "What would you like for dinner my Love? Chicken, beef or lamb?"

I said, "Thank you, dear, I'll have the chicken."

Her voice raised about one octave as she replied, "You're having soup, you dope. I was talking to the cat."

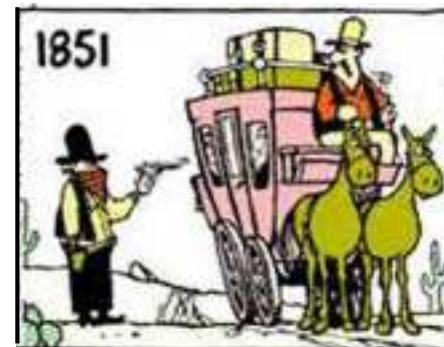
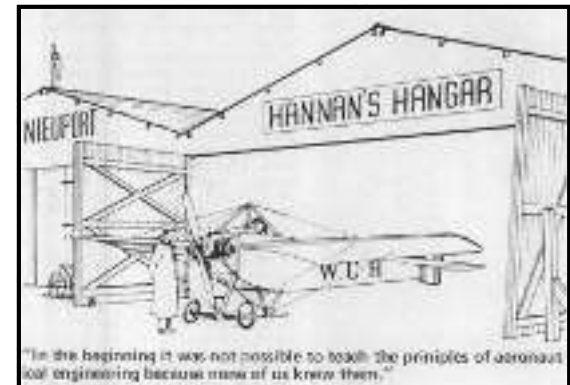

SAM 1993
SOUTH AUSTRALIA
 (Formed 1993)



COMMITTEE

President: Rex Brown 0468 448 375
 Secretary: Peter Leaney 8337 2836 pleaney@bigpond.net.au
 Treasurer: Don Howie 8271 6678 donhowie9@gmail.com
 Meetings held at the home of Rex Brown from time to time

S.A. OLD TIMER ASSOCIATION - SAM 1993
VINTAGE GLIDER 13th DECEMBER, 2019.

Report and photos from Don Howie.

This was the 3rd event for the 2019 year and we had six entrants. We had four LuLu Mk2 models plus a Gamma Gull and a Frog Prince.

Ray Bobrige broke a wing joiner on the first flight and did not record a score, so is not included in the results.

Dave Markwell achieved a 6 minute max in the second round, as most found it difficult with the 150 metre line length to the turn-around.

Peter Leaney with his light-weight 100 inch span Lu Lu Mk.2, had a very good day, recording 3 maxes over 4 rounds, something never done before in our Vintage Glider contests using the short winch line.



The Greatest Vintage Glider - LuLu Mk.2 - by John Barker.
 Left to Right: Ray Bobrige, Dave Markwell, Peter Leaney, Don Howie, Ivan Stacey.

The great flights by Peter Leaney gave him the slight edge of points for the year and he won the Vintage Glider Trophy for 2019.

RESULTS:-	1st	Peter Leaney	Lu Lu Mk. 2	1080 points.
	2nd	Dave Markwell	Lu Lu Mk.2	976 points.
	3rd	Chris Britcher	Frog Prince	967 points.
	4th	Don Howie	Lu Lu Mk.2	850 points.
	5th	Bill Britcher	Gamma Gull	753 points.



Peter Leaney after winning at Willunga Vintage Modellers Flying Field with his 100" span (double size) LuLu Mk.2
 Peter won Vintage Glider Trophy for 2019 year.

It is interesting that the 1949 Lu Lu Mk.2 is the most popular glider in South Australia. The model on the right, held by Ivan Stacey (group of five models) is now owned by Bill Britcher. Ivan has now given away flying due to old age.

Keep flying and building, regards, Don Howie.



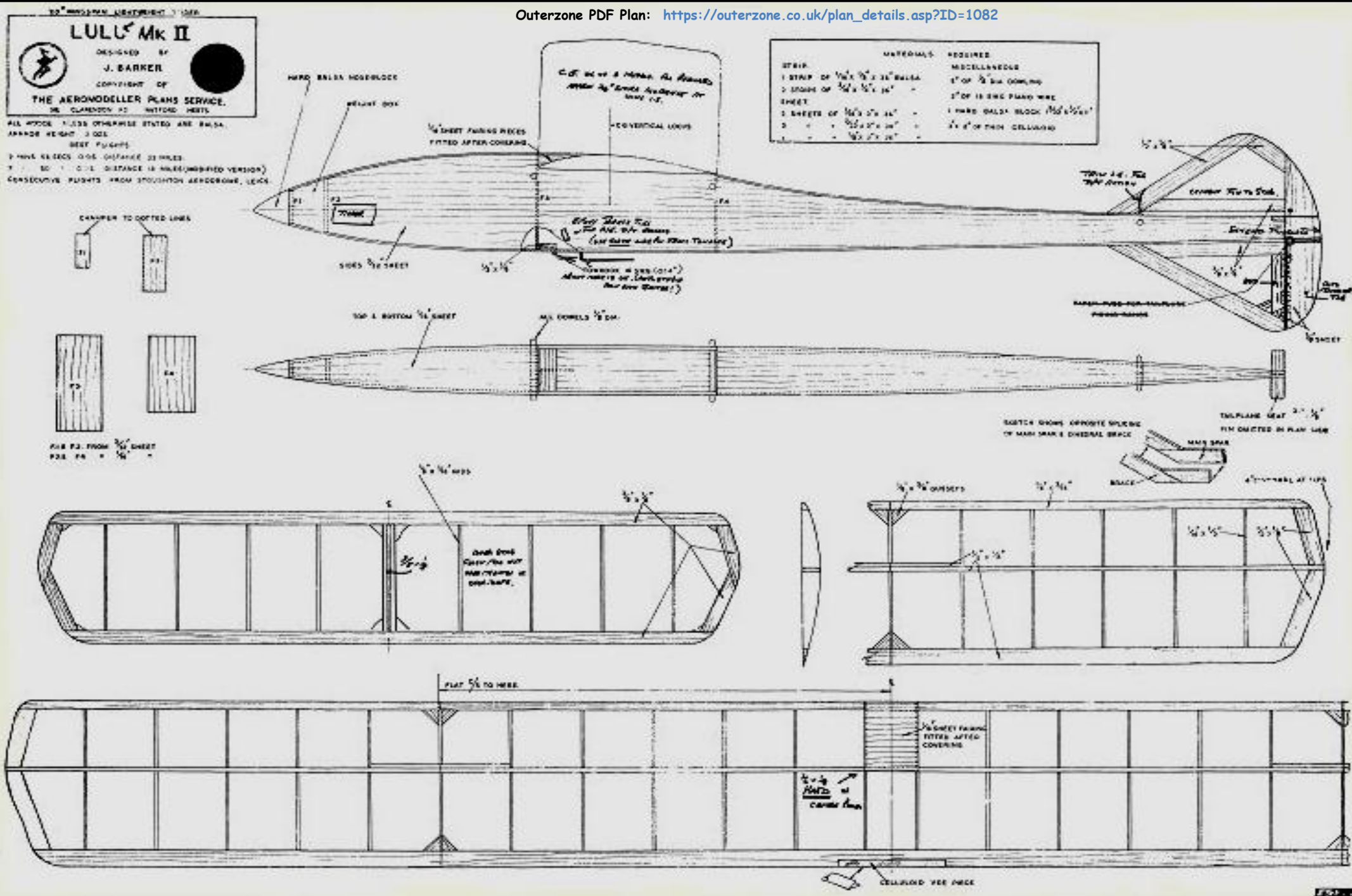



LULU Mk.2

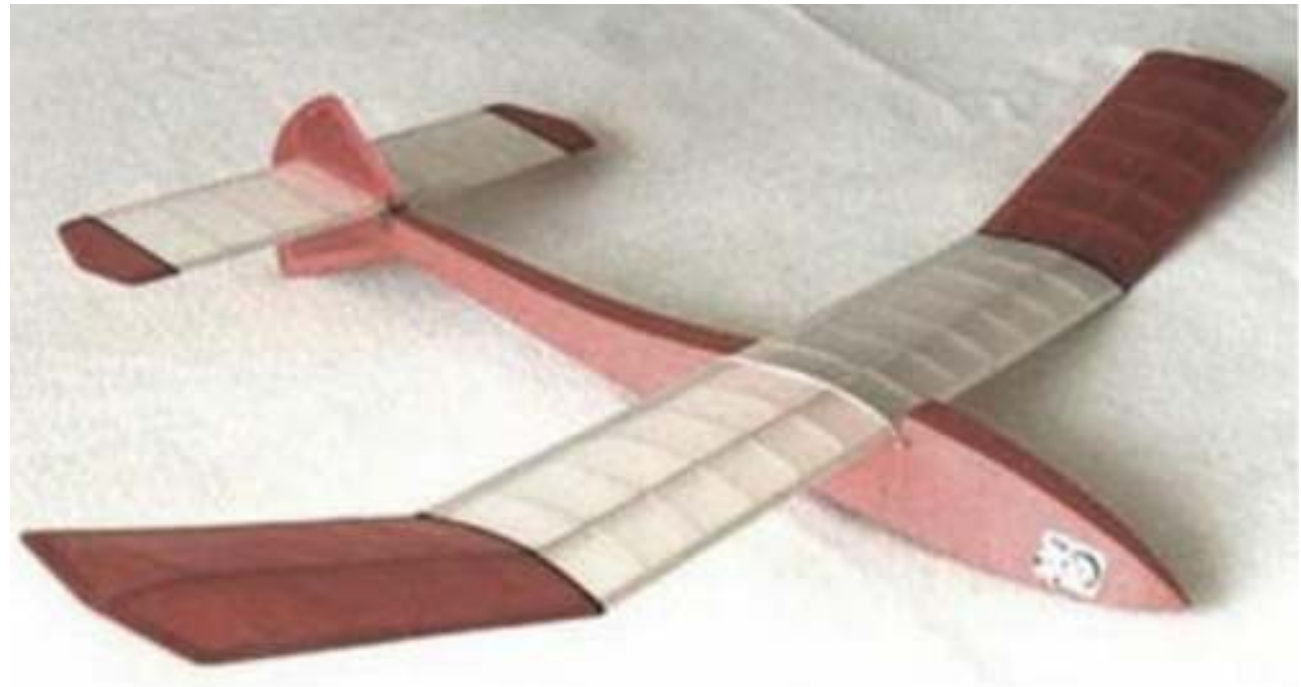
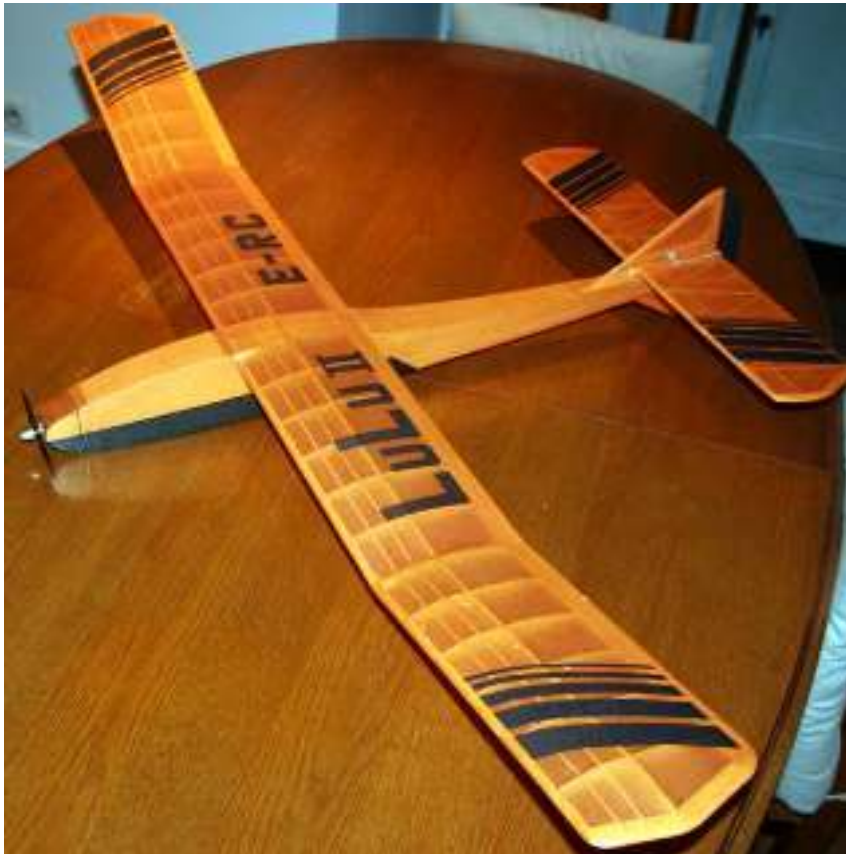



Official Journal of the WA Model Aero Club (Inc) and
SAM 270 Western Australia



SAM 270 Committee	
President: Troy Latta Mobile: 0404 810 233 Email: Troy.Latta@ncr.com	Vice President: Hans van Leeuwen Mobile: 0419 921 693 Email: hans.vanleeuwen@bigpond.com
Secretary: Graeme Cooke Mobile: 0447 508 883 Email: graemecooke@bigpond.com	Treasurer: Rob Bovell Mobile: 0420 356 125 Email: r_bovell@bigpond.com

SAM 270 REPORT - From Hans van Leeuwen.

Sadly, very little to report as far as SAM 270 goes. Fire bans, hot weather and strong winds have all contributed to little flying activity but we are doing fortnightly flying days at our Beverley field.

We had a flying day at our Beverley field on March 8 and were supposed to fly 1/2A Texaco. The weather forecast was for winds between 15-25 Km/hour. Five intrepid people turned up, three with 1/2A models, but the wind was too strong to fly small models.

We have decided to limit our contest calendar for this year, see my report in the inaugural AT, because we felt that that again may stimulate some interest in general flying for fun and that it may be a catalyst for people joining into our comps.

It has been proposed to run a couple of fun events to see if we can interest people from other aeromodelling disciplines and perhaps also ex-modellers and perhaps their off-spring. Our control line people have had some success with that sort of approach and have gained some new members and associates.

To this end our Club has ordered 10 Tomboy kits that we are prepared to sponsor for people to come along and have a go.

I haven't had contributions from anyone else, so this report is a lean effort, but I've included our proposed Contest Calendar for 2020.

Regards, Hans van Leeuwen.

Right: A blast from the past! At the 2004 MAAA Nationals at Busselton, WA. Paul Baartz instructing Simon Bishop (NSW) where the WA thermals usually are found at the excellent SWARMS Club Field, Bunbury, where the R/C Oldtimer flying took place. Grahame Mitchell (NSW) assisting Simon. The great facilities at the SWARMS field was very much appreciated by all.

WAMAC AND STATE CHAMPIONSHIPS CONTEST CALENDAR 2020			
	Free Flight Events	Old Timer Events	
8-Mar		1/2ATexaco	
22 Mar	Open Rubber		
05 Apr		Standard Duration	
12 Apr	Easter Sunday		L Wkend
19 Apr	Slow Open Power		
03 May		Texaco	
17 May	E36 / Open Electric		
31 May		Duration	L Wkend
14 Jun	P30 / Coupe		
28 Jun		38 Antique	
12 Jul	Open Power		
26 Jul		Nostalgia / Burford	
09 Aug	Combined FAI / 1/2A Power		
23 Aug		OT Glider	
06 Sep	Fathers Day		
13 Sep		1/2A Elec / Tomboy	





President: Tony Hart
Phone: 4923528
Email: t.hart1946@gmail.com

Treasurer: Ian Alexander
Phone: 32028464
Email: ial32263@bigpond.net.au

Secretary: Mike Moore
Phone: 4451740
Email: mooresam84@hotmail.com

From Mike Moore,
 Secretary,
 Vintagents, SAM 84.
 mooresam84@hotmail.com

We have so much uncertainty this year and thus nothing to submit at this stage. Our contests will probably be replaced by fun fly days for whoever is able to turn up on the day with so much uncertainty because of the Corona virus. If any material comes to hand for TATI'll forward on. Cheers, Mike Moore.



**Old
 Timer
 flying**
 in Queensland

FOR SALE

 Ignition coil assemblies with transistor - ready to go. \$70
Peter Scott
 (02) 9524 1262. qualimag@optusnet.com.au

FOR SALE

THE MODEL BUILDER

1930

DO YOU KNOW?

THAT Canada carried more freight and passengers by air in 1928 than did the United States? Extensive use of planes by miners going to remote districts and the activities of more than 4,000 members of flying clubs are credited with a large portion of the total of 74,689 passengers and 2,404,682 pounds of freight.

THAT air mail service in the United States covers 75,000 miles a day?

THAT the model used by Alan Loofbourrow of Columbus, Ohio, in the 1929 A. M. L. A. Stout Contest weighed only one-twenty-sixth of an ounce?

THAT the Detroit News has a specially-built Lockheed Vega, painted a brilliant red, in which to take reporters and photographers

to the scenes of important news events?

THAT movies will be shown as a regular daily feature for passengers of transcontinental transports? A program of news reels and comedies will be changed twice weekly.

THAT balsa, the wood that has made so many records possible, grows only in the tropics and weighs half as much as cork?

THAT Tempelhof Airdrome, the great airport of Berlin, is within the city limits, fifteen minutes from the business section?



It now serves twenty-nine different airlines.

THAT a Fokker factory to build the giant F-32 monoplanes is to be put up at Los Angeles, at a cost of \$300,000?



ALICE SPRINGS Masters Games

10-17 October 2020

The Friendly Games



<https://www.alicespringsmastersgames.com.au/>

History

In the early 1980's the Australian Sports Commission first suggested an idea of a masters games and the philosophy of masters sport. The development of masters sport included an underlying belief that each participant is a champion in his or her own right, as long as the physical and mental attributes for each stage of life have been maintained at their optimum levels.

The Northern Territory Government immediately embraced the idea seeing potential opportunities for economic and social development benefits, so in 1986 the first ever Masters Games event in Australia was held in Alice Springs.

The 1986 Alice Springs Masters Games (then called the Central Australian Masters Games) became only the second event of its kind to be staged in the world. The only previous multi-sport masters games was the first World Masters in Toronto, Canada in 1985.

The Games and the concept developed in to a success story and quickly earned the reputation of 'The Friendly Games' because of the camaraderie and good spirited nature of the competitors and the environment created by the games village atmosphere of Alice Springs. That spirit is now carried around Australia and overseas by the thousands of people who have experienced the Alice Springs Masters Games.

The 'Friendly Games' tag has stuck ever since and it is easy to see why. The Alice Springs Masters Games has reached some amazing milestones over the years. In 2004 the Games celebrated 10 successful games, and then in 2006 the Games rejoiced as they reached 20 years of prosperous Games in Alice Springs. What is even more extraordinary is that over 100 competitors, officials and volunteers have been a part of the Games since 1986 - a remarkable achievement for all those people.

Participation in sport is a lifelong activity. Masters sports contain fun, camaraderie and good-spirited competition. That is why the Alice Springs Masters Games adventure continues in 2020.



Model Aircraft Flying

Registrations:
<https://asmg.fusesport.com/registration/1239>

Sunday 11
TBA - Runway 1: IMAC Practise, Runway 2: Glider F5J and Old Timers Practise, Peddler Field Undoolya Rd

Monday 12
TBA - Runway 1: IMAC Practise, Runway 2: Glider F5J Competition, Peddler Field Undoolya Rd

Tuesday 13
TBA - Runway 1: IMAC Practise, Runway 2: Old Timers Competition, Peddler Field Undoolya Rd

Wednesday 14
TBA - Runway 1: IMAC Competition, Runway 2: Glider F5J Competition, Peddler Field Undoolya Rd

Thursday 15
9:00am - Runway 1: IMAC Competition, Runway 2: Old Timers Competition, Peddler Field Undoolya Rd

Friday 16
TBA - Runway 1: IMAC Competition, Runway 2: Glider F5J Competition, Peddler Field Undoolya Rd
TBA - Runway 1: Contingency, Runway 2: Old Timers Competition, Peddler Field Undoolya Rd



Allen-Mercury AM 10 1cc Diesel. from Model Aircraft July 1956.

In general, the model trade is not noted for modesty when advertising its wares. "Undisputed Leader! The World's Best! "X Leads the Field!" shout the manufacturers, until such claims by their sheer extravagance and constant repetition, fail to make the slightest impression on the hardened modeller.

Sometimes, too, the claims bear not the slightest resemblance to the products themselves. For example, we have had for test an engine which we would have been accurate in describing as a mediocrity; yet this, according to the manufacturer's announcements, as quite the finest model motor that had ever been seen. With all this in mind, the experienced enthusiast will probably pay scant attention to the distributor's claim that the new Allen-Mercury "10" has the highest output of any 1cc diesel in production today.

Certainly he cannot be blamed for doing so. Yet, in this instance, he would be completely wrong, for the new AM "10" certainly bears out this claim and more. The maximum power output of our test AM "to" it will be observed from the accompanying performance curves, reached 0.118bhp at 14,000 r.p.m. Students of model engine performance will be quick to realise that this is equal to a specific output of 118bhp/litre and is substantially in excess of anything previously reached with a 1 cc engine, the best of which have not previously exceeded 90 - 95 bhp/litre while a typical "popular" 1cc model achieves only about 65bhp litre. It is also one of the highest specific outputs yet realised with any model diesel, irrespective of size. In fact, as the M.A. Engine Tests series has shown, there are only two other model diesels, at the present time, capable of equalling or surpassing this performance, namely the 2.43cc Oliver Tiger III (0.305bhp or 124bhp/litre) and the 2.45cc Webra Mach-i (0.295bhp or 120bhp/litre), both of which are, of course, international class competition engines, recognised as being the best of their type.

It must be mentioned that our test figures for the AM 10 relate to a single test sample only as submitted by the trade distributors, Messrs. H.J. Nicholls Ltd. However, we are assured by Henry Nicholls that this was, in fact, a perfectly standard "off-the-shelf" model which had had no more than minutes running and we are further informed that a rough check on the performance of another stock example showed an output of 0.121bhp. The substantial improvement over existing small diesel standards of performance by the AM "10" must inevitably raise the

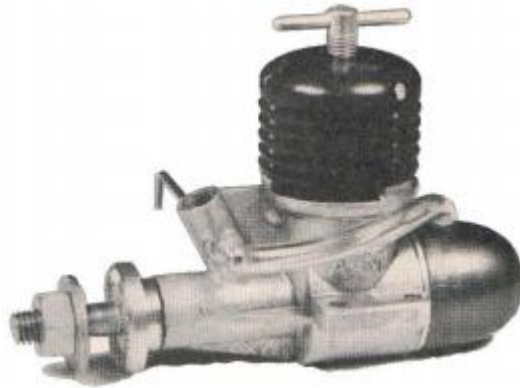

question, "how has it been achieved?" The space allotted to these reports does not allow the inclusion of a detailed design analysis (such analyses, on outstanding engines, are to be found,

from time to time, in our other engine features) but we can, at least, sum up. The AM "10" is a perfectly normal design in so far as it is a shaft valve, plain bearing, radial port diesel. Its performance comes, not from any one feature, but from an intelligent interpretation of the more desirable features of such a layout, which features have been harmoniously blended to produce a well-balanced design. (Here, incidentally, it is especially refreshing to find that the designer admits the engine has exceeded his own expectations.) Of the many features influencing two-cycle engine design, three factors (to which most others are, in any case, allied) assume prime importance. These are (a) adequate and balanced porting, (b) the prevention of excessive friction in the moving parts and (c) the prevention of overheating and/or thermal distortion.

In the first, the AM "10" looks no different from many other engines and, like any other, its porting has to be a compromise, but in this case, aided by a slightly higher than average stroke/bore ratio and a suitable cylinder design, the compromise appears to be a particularly well-chosen one. Secondly, the reduction of frictional losses is taken care of by a well-fitted piston and cylinder in which the cylinder bore is convergent towards the head in order to combine good compression seal with reduced piston drag over the major part of the cycle. In addition, bearing surfaces are of adequate area. Finally, the engine is notable for the rigidity of its construction and especially for its quite exceptionally heavy cylinder, which, by its considerable mass, must greatly improve efficient heat dissipation and eliminate any risk of localised overheating and distortion. The liner is, in fact, of some 5/64in. wall thickness above the ports.

Specification:

Type: Single-cylinder, air-cooled, reverse-flow-scavenged two-stroke cycle, compression-ignition. Shaft type rotary valve induction. Circumferential exhaust and transfer porting. No sub-piston supplementary air induction.

Swept Volume: 1.000cc (0.0610cu.in.).

Bore: 27/64in. Stroke: 7/16in.

Compression Ratio: Variable.

Stroke/Bore Ratio: 1.037:1.

Weight: 3.0 oz.

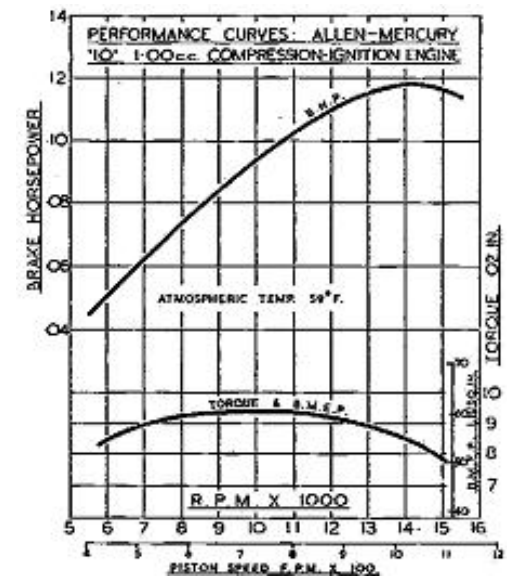

General Structural Data:

Pressure die-cast crankcase and main bearing housing in LAC 112A alloy.

Crankshaft of S.14 steel, case-hardened, with full-disc web and running direct in crankcase material. Splined shaft end for prop driver. Meehanite cylinder liner. Duralumin tinned cylinder barrel. Cylinder assembly clamped axially to crankcase by three long screws passing through cylinder barrel into crankcase. Meehanite piston with full-floating gudgeon pin. Connecting-rod machined from forged dural bar.

Spray-bar type: needle-valve. Beam mounting lugs.

Test Engine Data:

Running time prior to test: 2 hours.

Fuel used: 37% Technical ether BSS.57q. 20% Shell "Royal Standard" kerosene, 15% gas oil, 25% Castrol M, 2 ½% iso-amyl nitrite.

Performance:

The high maximum b.h.p. output of the AM "10" has already been remarked upon. It remains only to say that a proportionately high level of performance is available at speeds below the peaking speed. In other words, the performance comes not merely from the engine's ability to rev, but from unusually high b.m.e.p. Thus, the maximum torque, which is developed in the region of 10,000 rpm, was 9.4oz.in., equivalent to a b.m.e.p. of slightly over 60lb/sq.in., which is a much above average figure for model two strokes, irrespective of size and type. By way of comparison, the average for seven 1cc engines previously tested in this series was only 47.9lb.sq.in.

Handling characteristics in general were good. We had the engine started for the first time within a few seconds from cold after merely choking the air intake. Re-starting the engine when hot was, perhaps, a little less instantaneous. As one might expect, hand starting on small props, allowing static speeds in excess of 13,000 rpm, needed to be performed a little more cautiously if "biting" was to be avoided. The engine was responsive to the compression lever, and the contra-piston moved smoothly and with no tendency to seize when hot. The fine thread compression screw was an excellent fit in the head and there was no tendency for the compression adjustment to slacken off at ultra-high speeds.

The engine was given a brief check period at 8,000 rpm and was then loaded for two hours' running at a speed of 10,000 rpm, at the end of which period an increase of

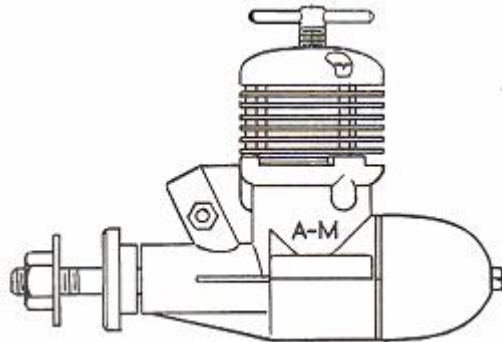

just under 500 rpm was evident, equivalent to a power increase of nearly 1%. Some trouble was taken to select the best fuel mixture for the particular engine and of several tried, the blend mentioned previously was found to be slightly superior. Having now almost reached the end of this report, we are conscious that we have said very little in criticism of the AM "10."

Therefore, we would mention that the needle-valve is a trifle close to the prop disc, while the engine is, perhaps, heavier than some people consider necessary in a 1cc unit. Yet, against this, we cannot help but point out that the needle-valve, by not being raked back, allows it to be reversed for side or inverted installations, while the weight is by no means excessive and, in any case, is more than compensated by improved performance.

In all, this is a fine little engine and one which, should the trend of future International rules favour a smaller type of competition F/F model, will help to place Great Britain in an extremely good position.

Power/Weight Ratio (as tested): 0.629bhp/lb.

Specific Output (as tested): 118bhp/litre.

The Battler

by Ron Moulton
from Model Aviation
Summer 1950.

First Team racer design to be published in Great Britain.

The Battler was originally designed for the ELFIN 249 diesel but it will also take the 1.8 ELFIN, the ARDEN 19 or OHLSSON 23 with appropriate cowl modifications it is proven, rugged and extremely stable in flight.

The Battler can be built in 5 evenings if you follow these easy stages of construction.

The wing must be made first, then the fuselage fitted to the wing, the tail plane to the fuselage, the cowling to the nose, then the rudder and finally the fuselage bottom. Add ballast to achieve the correct C.G. position (on the front line), 1½ ounces will be needed in the case of the Elfin 2.49 version.

STAGE 1

Butt joint 1/16-th sheet Balsa to make an accurate planform of the wing. Then repeat for the top surface but allow 3/16ths extra width for the curvature. Lay the lower surface on a flat board, bevel the leading and trailing edges (for ¼") to a sharp edge and stick the ribs in position. Remember to cut out slots in the port wing ribs to allow for control wire movement. Cut a piece of 1/8" plywood 2" x 1", drill a hole in the dead centre (1/8" in diameter), insert this as a bell crank pivot support.

The lower surface must then be lifted from the board and the completed bell crank assembly fitted and soldered. Allow 1½" extra on the push rod to the elevator. The upper surface may now be fitted. Slow-drying cement is advisable since

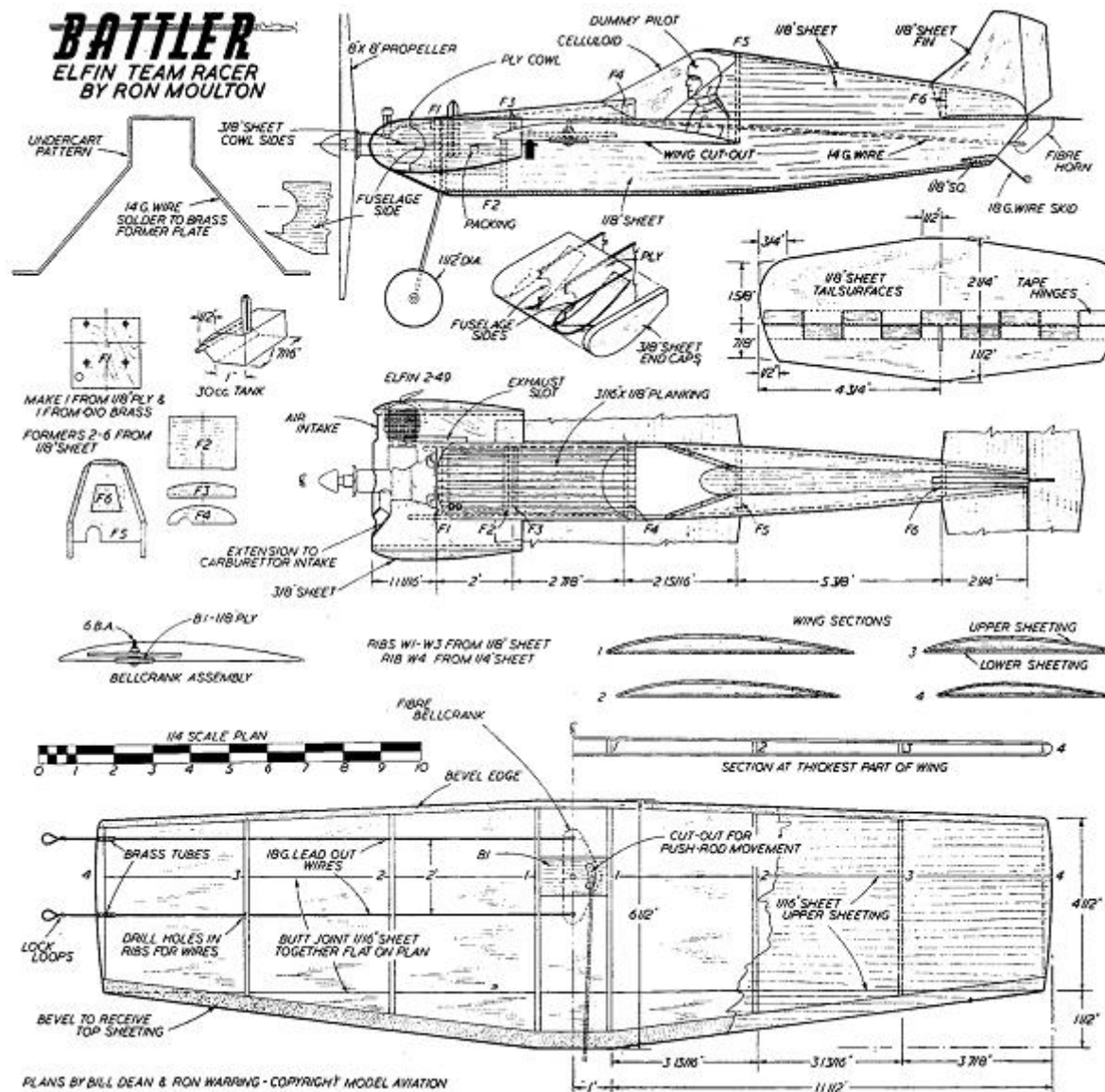

all joints, i.e., leading edge, trailing edge and wing ribs, must be made at the same time. Use plenty of pins, or better still strong spring paper clips and make sure that there are no warps. It is easy to correct warps while the cement is tacky by merely sliding the surfaces.

The wing tip ribs can be sanded to shape and the leading and trailing edges given a radius. The hole through which the bell crank bolt projects in the upper surface may be reinforced by balsa cement or a plywood patch. Ensure that full movement of the bell crank bolt is possible and that there is no limitation of the range of movement, by cutting a large clearance slot in the top surface for the push rod. Cover with light weight Modelspan and give one coat of clear dope.

STAGE 2

Cut out the engine bulkhead and the tin plate, then solder the undercarriage and engine bolts to the tin plate. Then fit the engine to the bulkhead and solder the nuts to the engine bolts. This is essential. Make a tank from tin plate and check that it is not more than 30 c.c. capacity. Actually, because it is difficult to solder a flush air vent you will find your tank capacity to be very near the American ounce, i.e., 29.5 c.c.

Cut from hard 1/8" balsa the two fuselage sides and slide each into position over the wing. Cement the engine bulkhead to the fuselage sides and the fuselage sides to the wing, at the same time checking that the thrust line is neutral in plan and side view. Place the tank in position and block with scrap 1/8" balsa. Connect the engine and tank with small diameter non-kink neoprene tubing.

STAGE 3

Whilst the vital engine bulkhead joints are drying, the tail plane and elevator can

be cut from 1/8th sheet, sanded to section and joined with linen hinges. Cover with light weight Modelspan and give one coat of clear dope. Fit a fibre elevator horn to the elevator. Bend the push rod at right angles to join up with the elevator horn, lock this joint with soldered cup washer. Cement the tail plane to the fuselage sides, which are pinched together as shown in the plan view. Before the tail plane joint is completely dry slide back and forth to obtain the exact neutral elevator position when the wing tip lead-outs are also neutral.



STAGE 4

Cut out the three fuselage formers and fuselage upper sides, fit your pilot to the top wing surface and complete the upper rear fuselage. Bend 18 gauge wire skid and bind tightly to a hard 1/8" balsa block. Then cement into position as shown. Cut from .8 mm. ply (1 mm. is satisfactory but more difficult to work with) the cowling with holes cut for cooling intake, main beating, needle valve and carburettor. Cut from 3/8" balsa (or thicker if you wish for a deeper cowling top) the cowling tops and cement these into position on the leading edge of the wing. Remove the engine nut and driving hub and cement the cowling into place making sure of a good joint at the engine bulkhead. Plank the fuselage top surface back to the cockpit. Fit the fin and finally cover the fuselage bottom with 1/8th sheet and solder the wheels to the undercarriage.

FINISHING STAGE

Sand with 3/0 garnet paper to a reasonable surface. Then cover the entire fuselage and fin with light weight Modelspan and give one coat of clear dope. It is not necessary to cover the plywood cowl. Apply successive coats of sanding sealer (we used 3 ozs.) until you are satisfied that you will get a good finish. Leave for 24 hours and then sand with wet abrasive paper, using soapy water or petrol to clean the paper. Dust the job down with a soft rag and apply two coats of the desired base colour (ours was yellow). Cement wind shield into position and trim with the decorative colour (ours was red) and add transfers. We applied the



racing number in the Goodyear fashion on either side of the fuselage on the port upper and starboard lower wings with our insurance number on the opposite wing panel. To mark in the ailerons and rudder use Indian ink and a ruling pen over a surface dusted with anything from boracic powder to French chalk. Apply one coat of fuel proofer to the entire model, but not until you have made sure that the transfers are completely free of water, otherwise they will wrinkle. It takes at least 12 hours for the transfers to completely dry.

Use an 8 x 8 propeller, 52' 6" of .011" control line wire and you will find the Battler as simple as an elementary trainer to fly.

It meets SAME regulations for Team racers and with the addition of a fuel cut out will conform to the 1950 All-Herts Rally Rules. A shut off valve can be fitted between the tank and the tin plate with a connection to the push rod. The tank must be moved 5/16" aft to accommodate the cut out.

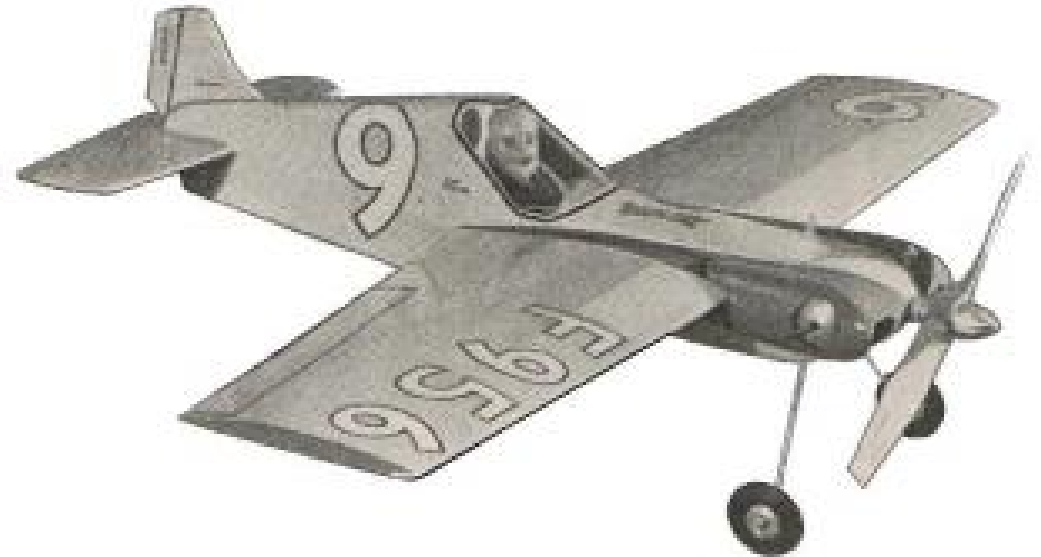

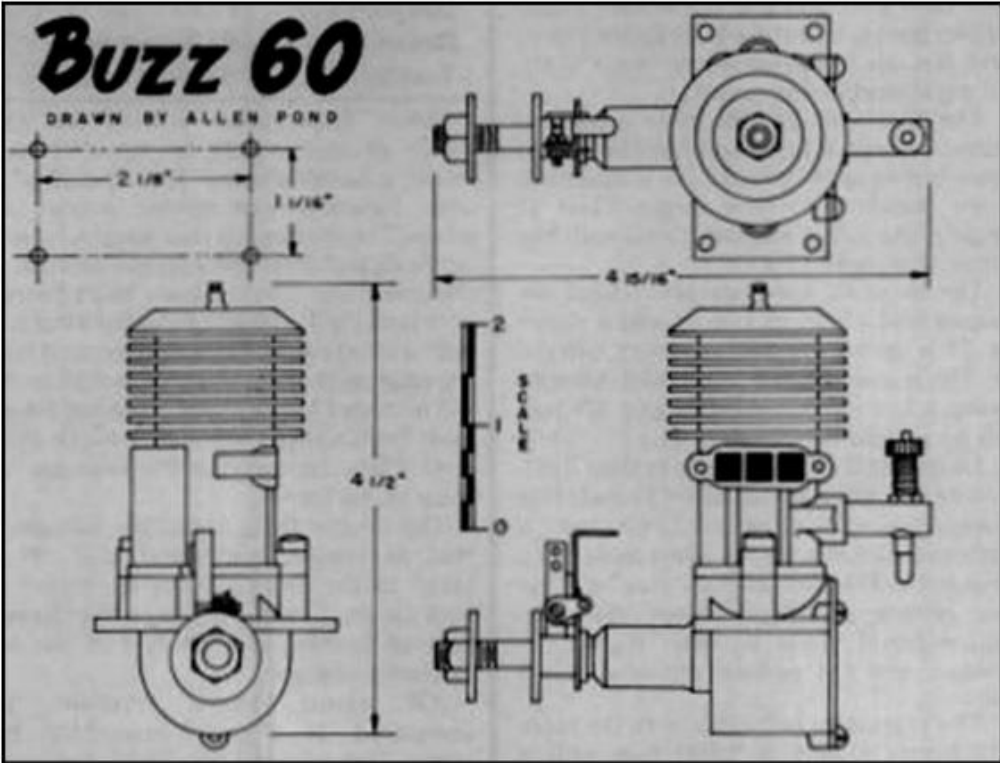

GARA POSTALE
Frank Ehling 2019 - 8 September 2019
The Frank Ehling 1/2A Postal Texaco Challenge 2019
Results
From Walther Gianati SAM Chapter 62 Italy

We have winter at our doorstep and this brings us to mind the good times we spent in joy in confronting ourselves in a distance meeting based on everyone's trust.

This 2019 brought luck to the SAM 114 team (USA) by giving a day full of sunshine and above all the right thermals to bring them to victory, congratulations.

Nice score achieved by Sam 2001 greater than about 1000 points compared to 2018, thus taking second place.

The rest of the teams failed to exceed 4000 points but I am convinced that the spirit of participation leads to overcoming the difficulties that arise in each race.

A merit to the Argentine team who have taken this meeting as a moment of socialization and fun, dreaming of being in flight with their models, a dream shared by all those who practice model aircraft.

In the queue we find the Slovak team that will find better results in the future helped by the beautiful Nitra airfield.

A thank you to all the teams that took part in the possibility of continuing and always being more numerous in the 2020 meeting.

Health to all.

Walther Gianati
 SAM Chapter 62 Italy



Overall Results

PLACE	Chapter	Club/location	Country	Score
1	SAM114	W.o.r.k.s. West Ohio	USA	4.962
2	SAM 2001	Fiano Romano near Rome	Italy	4.124
3	SAM 78-95	Airport Horice, Zatecany	CZECH-R.	3.842
4	SAM 62	Ala Azzurra field Ferrara	Italy	3.566
5	SAM 27	Novato CA	USA	2.986
6	SAM 1953	Baradero	Argentina	2.889
7	SAM 43	Cookeville	USA	2.808
8	SAM 119	Airport Nitra	Slovakia	2.685



2nd Place Overall - SAM 2001 Italy - Fiano Romano (near Rome)

Contestant	Model	Area (Sq in)	Weight Oz	Flight 1	Flight 2	Flight 3	Best (2 of 3)	Team Score
Wessely Giancarlo	Diamond	320	19.5	608	837	0	1.445	1.445
Cassinis Andrea	Airborne	288	17.5	722	698	0	1.420	1.420
Santoni Curzio	Sinè 46	305	18.5	536	726	0	1.262	1.262
Moschini Giuseppe	Mini Hogar	305	18.5	665	546	510	1.211	
Baldari Ugo	Kerswap	288	18	392	510	0	902	
Sagnotti Maurizio	MG 2	240	14	319	345	455	800	
Cavallaro Eros	Play Boy	300	18	335	311	0	646	
							Team score	4.127

SAM: SAM 2001 L'Aquilone
 Date 19.10.2019
 Location: Fiano Romano near Roma
 Condition Weather :
 Sunny, light wind, jome thermals
 Team Manager: Curzio Santoni SAM 2001



4th Place Overall - SAM 62 Italy - Ala Azzurra field Ferrara

Contestant	Model	Area (Sq in)	Weight Oz	Flight 1	Flight 2	Flight 3	Best (2 of 3)	Team Score
Artioli Gianni	Diavolo	302	16.93	482	680	604	1.284	1.284
Sabadini Vinco	Sinè	295	16.5	405	725	434	1.159	1.159
Monti Matteo	Top Banana	300	16	515	576	547	1.123	1.123
Minarelli mauro	Civy Boy	210	12	518	390	117	908	
Gianati Walther	Diavolo	302	16.8	186	434	351	785	
Cavicchioli Giorgio	Play Boy	288	16	474	195	292	766	
Borsetti Gianni	Kerswap	288	17	448	87	89	537	
Mauro Pietro	Civy Boy 31	290	16	LOST ON THE FIRST FLIGHT			0	
							Team Score	3.566

SAM: SAM Chapter 62 Italia
 Date: 29.09.2019
 Location: Field flight Ala Azzurra ferrara
 Conditions:
 Cold wind from the east-west 4-5 m/s
 Temp: 19°C
 Team Manager: Walther Gianati SAM 62



Chet Lanzo's Airborn Glider

by Don Bekins

Bucky Walter first told me about the model and sent me the pictures he had. I wrote the background details in SAM Speaks, May-June 1992.

In September 1988, Bucky asked Chet to draw up a side view of his 1938 RC Glider along with his letter which was printed on the plans. Bucky asked Stu Warner to ink the plans so he could have a contest within SAM 39 to name the model. The winner would receive the first set of plans. I think I received the second set. Bucky submitted the name *Lanzo Pioneer One*, but Chet chose the name *Airborn* from among the entries received. It was Chet's original name, but his wife, Peggy, didn't like it.

In 1992, Bucky sent me the plans, but I was so busy with editing SAM Speaks that I did not have time to build it. I sent the plans to Nick Nicholau who volunteered to frame it as a favor to me. It was about this time that Nick started getting sick, unknown to his friends. He did a good job of engineering the changes to adapt to an engine mount and removable glider nose cone. He also did a good job on a removable wing tips. Nick passed away in February of this year, so never saw the model finished, but his wife Neva



Don flies the Airborn at the Schuster Ranch near Sacramento California.

has seen it and will be at the Las Vegas Champs helping in the RC booth.

The framed Airborn sat in my basement until this year when Gene Wallock announced in SAM Speaks that the model had been approved to compete as a power model as well as a glider. So after lots of work I finished it. Bucky sent me a copy of Chet's signature, which I scanned, enlarged, and made a decal of, which now graces the wing under the Airborn graphics.

I think Nick bent a landing gear for it, but I lost it and tried to follow the plan on the landing gear shape. That gear was created for the glider and Chet's one-man, hand-tow launch system. [See SAM Speaks #105] It works with the McCoy installed and its 12" prop, but not a 16" Texaco prop. One of the instructions I gave Nick was to do a re-

movable landing gear so the model, as a glider, could operate off a highstart. It works, but needed some booting up.

So, I will go to the Champs with the newly approved Airborn to fly in the following events: Old time Glider, Pure Antique powered by McCoy 60,

Texaco Ignition powered by an Ohlsson 60, Brown Jr. event powered by an original Brown D, and Classic Texaco with the same Ohlsson. The Airborn can be flown in the Class C LER ignition event as well, but I am going to enter my Ohlsson-powered Record Hound for that event.

The Airborn is a good flyer, or should I say floater. I believe it can compete

on equal terms with the Bomber. The finished model with its 1,350 square-inch wing came out light, perfect for the Brown Jr. event with its 8.1 OSP wing loading. I have add 22 ounces of lead to bring it up to the 10 OSP wing loading requirement for all other SAM events, except OT glider.

The added weight seems to have almost no effect upon the model's gliding and floating characteristics. If there are thermals around the day of the contest, the Airborn may be hard to beat.

Back in 1992, the Italians saw my article about the Airborn possibly being a power model and drew up a 1/2 A Texaco version that has become very popular in SAM Italia competitions. I must have seen 6 or more of them during my last two visits to Italy. A full size 1/2 A plan of the Airborn was included in one of the issues of *Aeromodellismo*, the top Italian aeron modeling magazine back in the mid-1990's.

Addendum following the SAM Champs. The Airborn flew very well, winning the Antique Event, flying against all the schneufle-powered, scaled and optimized antique models of the serious competitors.

It won the glider event missing a perfect 20 minute max flight by 2 seconds in a single 20 minute flight. The rules say you get three flights to make 20 minutes, subtracting



Steven Rosenfeld



To construct the removable nose, Don first built a balsa plug which he used as the form for a male mold. Then he laid up the fiberglass cloth over the plug and used his famous balloon method to form the nose cone. He says the balloon method produces excellent cowls and requires the use of merely 4 hands.

Don's model is believed to be the first such full-size Airborn to be gas engine-powered. Chet himself built only a glider, his first, and never drew full size plans.

Several scaled-down versions have been built in Italy for Half-A Texaco.

time over 20 or taking the flight times under twenty.

Because both the Glider event and Classic Texaco were on the last day, I missed the chance to get a good Classic Texaco flight. Being the Assistant RC CD, I was occupied all morning helping contestants launch their gliders. Then a very strong wind came up suddenly, damaging many models and preventing me from flying the Airborn up to its potential.

The SAM Champs was a great week of flying except for the last 2 1/2 hours.

Don Bekins
85 Bellevue Avenue
Belvedere CA 94920
(415) 435-4697
dbekins@pacbell.net

[Don Bekins is a former President of SAM, editor of SAM Speaks and current RC Coordinator.]

The giant nine-and-one-half-foot Airborn glides overhead to form a Polyspan overcast. Bottoms of the tips are colored black for increased visibility. All colors are dyed except the white nose, which is doped. Don reports it is a spectacular gliding model and will easily stay in a thermal.

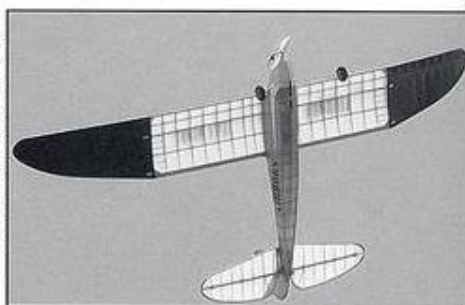

The cowl nose cone is shaped to fit the variety of engines Don uses to fly the Airborn in six RC events. He uses the O&R 60, McCoy 60 and Brown Jr., and has become quite expert at changing engines at the field, a feat which has earned him the title of SAM Champs RC Grand Champion on five occasions.

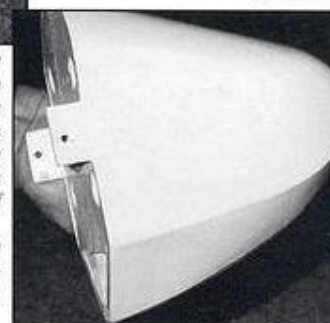

Above, the fiberglass nose showing the mounting tabs. Below, Chet's original glider in 1939, and his only sketch of the design, made in response to Bucky Walter's request in 1988. Towhook is visible behind the landing gear. The model was originally RC equipped for the 1939 Nats and was flown to 10th place against gassies with unlimited fuel.

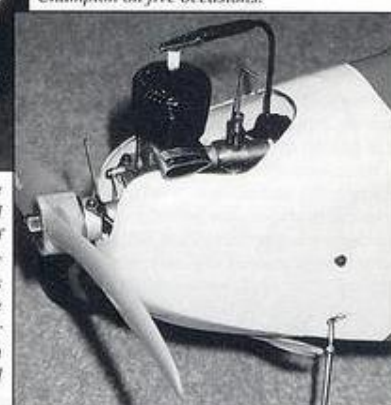

A note on the back of this photo said "This model can be easily converted to a gas job...."

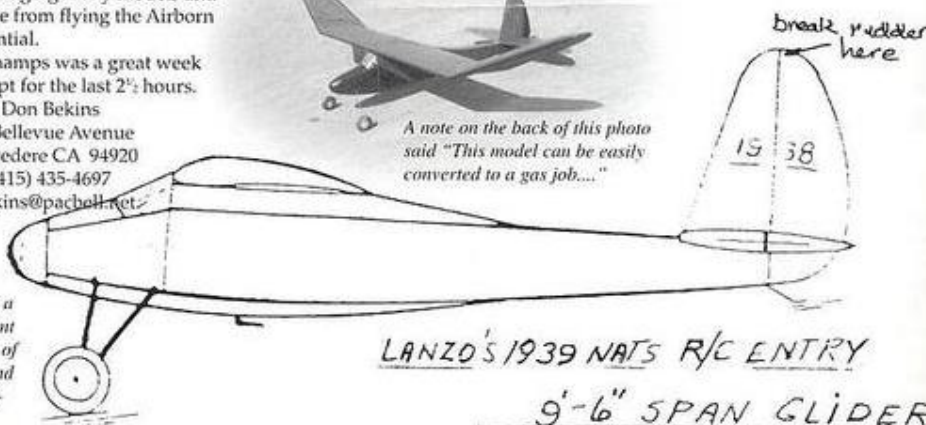

LANZO'S 1939 NATS R/C ENTRY

9'-6" SPAN GLIDER

Page 16

AIRMAIL

May + June 1992

"AIRBORN" GLIDER -- NEW PLANS
First ever R/C Glider from Chet Lanzo

Bucky Walter writes that Chet designed and built an R/C glider during 1938 to fly against R/C power models in the 1939 Nats. It was the first-ever R/C glider entered in the early radio control competition. Chet had Mr. J. Takacs draw 1/3 size plates that were intended for a magazine. They were never published.

In 1988 Chet drew up accurate rib patterns for Stu Werner to use in drawing up full size plans of the glider. Stu quit working on the drawings when Chet died. I finally got Stu to bring the plans to me. Enclosed is a letter from Chet to me (about the glider). I thought you would like the info. Quote:

"Enclosed find a sketch of the 1938 R/C glider that Stu now has the plans for. I thought up a name for it but Peggy did not like it. ("Airborn") You might mention in next epistle that the 1938 glider needs a name. Big hearted Lanzo will give a set of plans of the 1938 glider free of charge as a prize for the best name!

"The gear is removeable. The gear was put on for a one man launch (see sketch) I place 10th at the '39 Nationals with the glider. It was flown against gas engines powered planes. This model was the first ever R/C glider flown at the contests held at the Nats.

"Don't know when Stu will finish up the plans."

Yours truly, Chet Lanzo (signed)

Over: Back side of the letter:
"There were only 11 entries in the 1939 Nationals R/C event. So don't tell anybody! I had a bad launch at the Nats, the model towed up into a stall turn and bruised the radio on landing. That accounts for the bad showing." (CDL)

Bucky goes on —
"Remember, He who gets Thermal — Wins! An old saying from my good friend, Chet Lanzo."



"Airborn" before the '39 Nats



Chet at age 24 with his first ever R/C glider, "Airborn", flown at the '39 Nats against gas powered models. The plans may soon be available through the SAM Library.

Editor's note: Bucky sent me the 1/3 size plates. I promised I would work on getting them blown up to full size plans. The vellums are now done and several prints will be made to go to those who did all the work, like Bucky. The SAM Library will have blue prints available as soon as the Design Committee completes its review. On the back of the lower photo, Chet noted the possibility of making the "Airborn" into a power model. To the right is a scan of that handwritten note. Imagine, resurrecting a genuine antique that can be flown as a glider and a gas powered model!

THIS MODEL CAN BE EASILY CONVERTED INTO A GAS JOB BY REMOVING THE HOSE-BLOCK AND AND INSERTING A RIGID FIREWALL IN ITS STEAD.

This note was scanned from the back of the photo of "Airborn" to the left, then electronically "cleaned" of smudges as much as possible, then reduced to fit his column. Likewise, the diagram below was scanned from the back of Chet's letter and reduced.

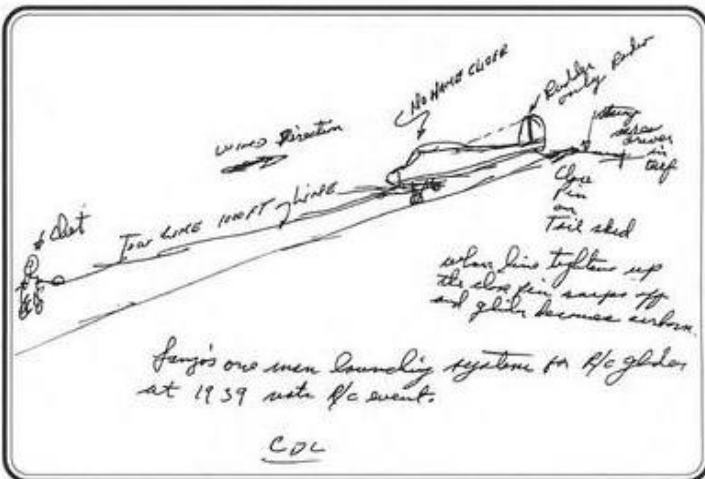

June 1946

MODEL AIRCRAFT

Now **FOUR GREAT PETROL MODELS**
GIVE YOU SUPERIORITY IN AIR POWER

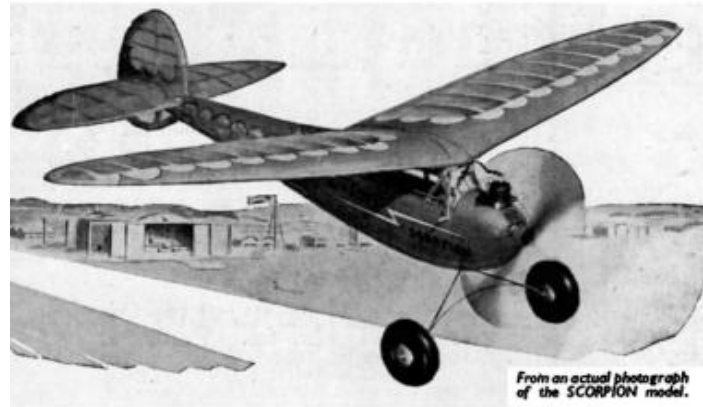

From an actual photograph of the SCORPION model.

HERE'S real air power. Pride of the skies is the giant FALCON, 8 feet from wing tip to wing tip. Performance figures though still secret are outstanding.

The JUNIOR, spanning 60", another newcomer to the Keil Kraft Air Fleet, is a notable addition to the SCORPION and HORNET. Kits for these four great petrol powered planes will be available soon but PLANS ARE READY NOW.

FLYING SCALE SERIES:

Look for these perfect scale models all at 5/6 each :- Zeke, Mustang, Tempest, Typhoon, Thunderbolt, Barracuda, Spitfire, Hurricane, Firefly, F.W.190.

GLIDER RANGE: 30" Victory Glider 4/6. 20" "Polaris" Solid Glider 2/6. 12" "Vega" 1/6. Invader 40" Glider 7/6.

ALL KEIL KRAFT Solid Scale Series contain crystal clear cockpits and powdered paints.

DURATION SERIES:

Polydi 40", Ajax 30", Achilles 24", Orion 28".

SOARER SERIES: 5 ft., 4 ft. and 3 ft. Minimowa 50" Gull Wing.

SOLID SCALE SERIES:

Mosquito	4/6	ME210	4/6
Lightning	4/6	Corsair	3/3
Avenger	4/-	Hurricane	3/3
Typhoon	3/3	Thunderbolt	3/3
Zero	3/-	Airacobra	3/-
F.W.190	3/-	Mustang	3/-
		etc., etc.	

FALCON

FREE FLIGHT MODEL. WING SPAN 8 FEET. SPEED STILL ON SECRET LIST.

JUNIOR

FREE FLIGHT MODEL. WING SPAN 60". SPEED STILL ON SECRET LIST.

SCORPION

FREE FLIGHT MODEL. WING SPAN 44". WEIGHT 29 oz. SPEED 30 M.P.H. KITS READY SOON. PLANS READY NOW.

HORNET

CONTROL LINE MODEL. WING SPAN 28". SPEED 60 M.P.H. KITS READY SOON. PLANS READY NOW.

PETROL ENGINES:

K 6: 6 c.c.
Spark Plugs 1/2 x 32 T.P.I.
3/8 x 24 T.P.I.
Coils, Condensers, Timers, etc., etc.

ACCESSORIES always available: Cements, Dopes, Wheels, Cowls, Transfers, Cockpits, etc. etc., true to usual Keil Kraft standards.

KEIL KRAFT KITS

WHOLESALE ONLY: E. KEIL & CO. LTD., LONDON, E2

Also distributors for: SKYLEADA, STUDIETTE, TRUSCALE, VERNON, ETC.

Correspondence with WHOLESALE TRADE ONLY. We regret we cannot reply to enquiries from private purchasers.

Outerzone PDF Plan
https://outerzone.co.uk/plan_details.asp?ID=3073

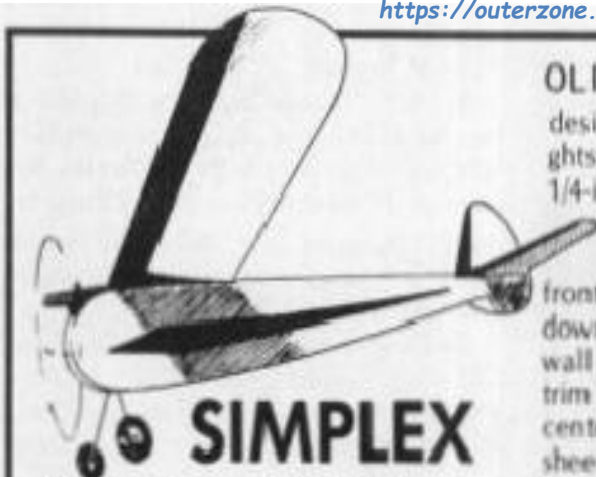

SIMPLEX

Designed by: Paul Plecan
 Drawn by: Al Patterson
 Text by: Bill Northrop

When Paul Plecan named this Old Timer of the Month, he couldn't have made a better choice. The "Simplex" is your basically constructed model airplane. The fuselage is four longerons with verticals and cross-pieces perpendicular to the centerline. The wing is a 10 by 60-inch constant cord, straight dihedral structure with a sturdy spar, leading edge, and trailing edge, with sheet wingtips, based on the old reliable Clark-Y airfoil. Stab and fin are built from various sizes of 1/4-inch thick strip. Plans appeared in the February '41 issue of *Air Trails*.

The unique thing about the Simplex is that as simple, traditional, and "Plain Jane" as the structure may be, it doesn't look klutzy. Functional, clean lines have a way of coming out on top in the appearance category.

Of course, every modeler (as compared to a parts assembler) has some "improvement" ideas for every

OLD TIMER Model of the Month design. I would suggest only a few thoughts on Paul's Simplex. Add a triangular 1/4-inch gusset that will surround the rear wing hold-down dowel (something to stick covering to) and add a front hold-down dowel about one inch down and just ahead of the plywood fire-wall (through the side cowl blocks). Also, trim 1/16-inch off the top of the three center section ribs so that area can be sheeted with 1/16 balsa (grain spanwise). By running your wing hold-down rubber bands criss-cross, you'll now avoid any damage to open covering material from the rubber tension.

By the way, as sturdy and light as this five-footer will be, it is an excellent choice for electric power. And if you wish to prevent loss of the model (the original flew away on its first day of testing, 33 minutes O.O.S. on a 15-second engine run!), radio can be added quite easily. For the rudder, measure in three inches from the trailing edge at the fin base and install two vertical 1/4-square spars, spaced 1/16 apart, from bottom to top. Trim away existing pieces to fit. For the elevator, you'll have to split it in two pieces to clear the rudder, beginning at the first stab rib out from the center. On the other hand, we've seen several models where only half an elevator is used... one side only. Much simpler (Simplex?) and works fine, with no side effects. A two to two and-a-half inch elevator chord should be sufficient.

Oh yes, Paul did mention the balance point. It's at the main wing spar. Again... Simple. Huh?

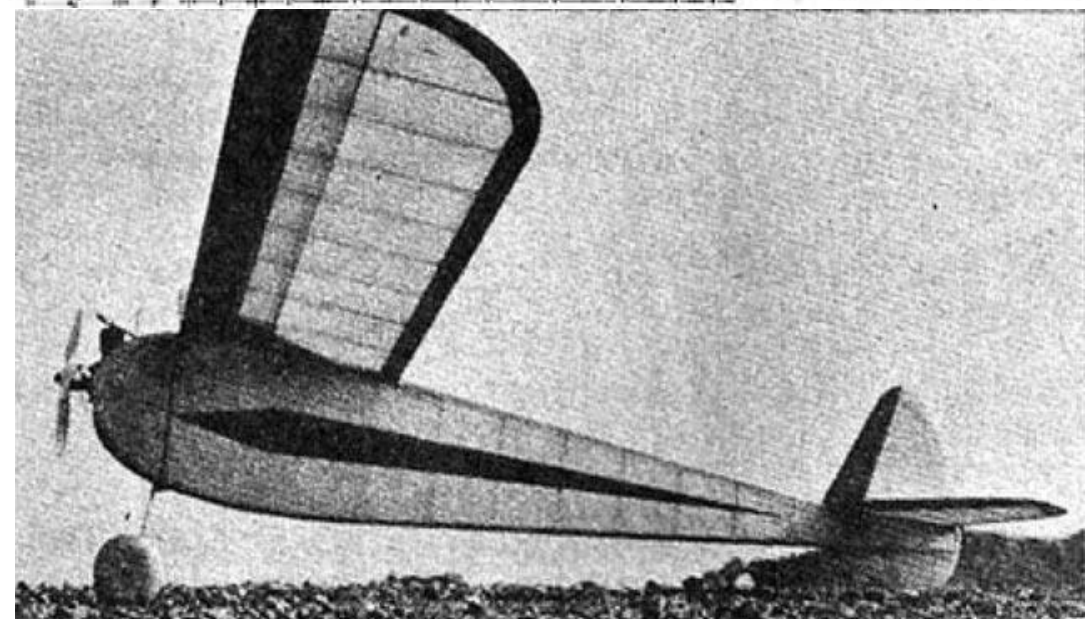
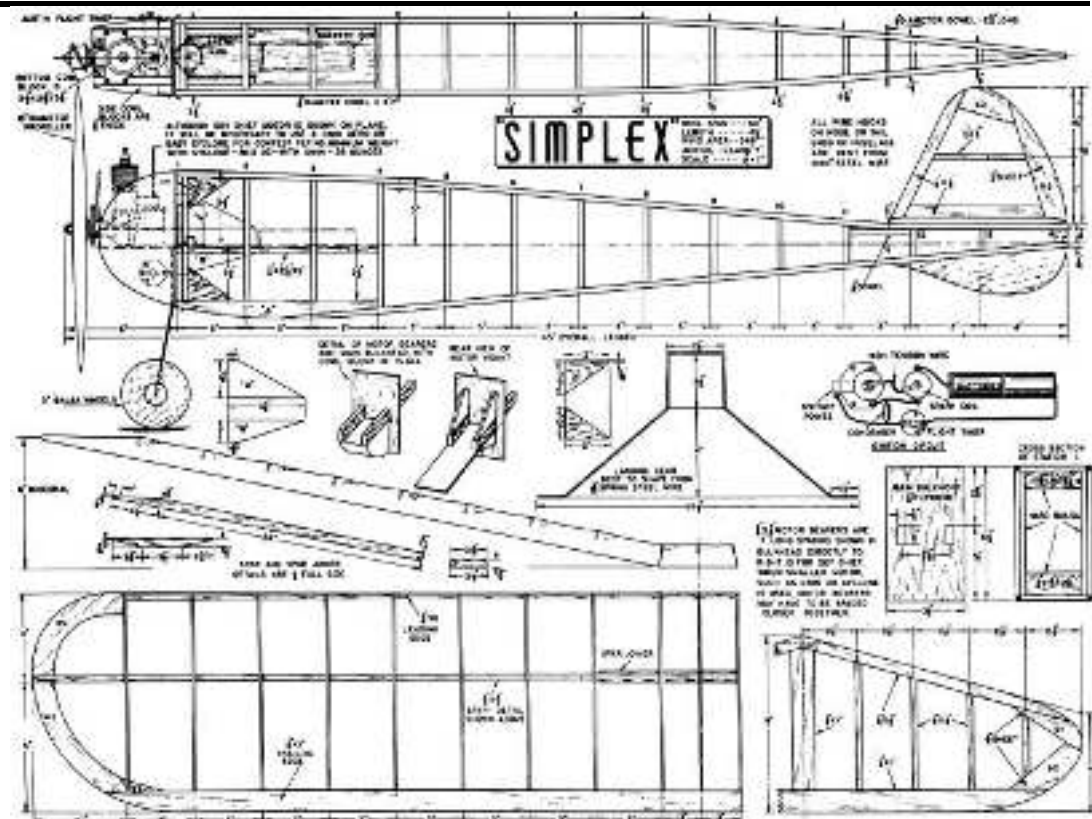



THE
YULON
49

NUMBER TWENTY-EIGHT



BY
L. H. SPAREY



It is perhaps as well for the maintenance of good relationships with my neighbours that engines of the 5 to 10 c.c. class are comparatively rare. Used as they are to the suburban noises which emanate from my workshop-cum-lab. I fear that my popularity would show a steep decline were there a sudden influx of the larger engines on the market.

With an output of over 800 b.h.p. at around 13,000 r.p.m. the Yulon, when in full blast, certainly sounds like it! Although my new workshop is lined throughout with sound-proof material it was necessary to shut windows and doors while the engine was performing—crawling into the open to breathe between runs.

Apart from the noise and the excellent performance, the Yulon "49" is remarkable for its appetite for fuel, and one could see the level in the tank rapidly lowering—something like drinking a glass of lemonade through a straw. However, it is only to be expected that such a high performance engine would show these characteristics. Power does not come from nowhere.

In many ways this engine has a character of its own. It was, for instance, run-in for 40 minutes at a speed of around 10,000 r.p.m., simply because it seemed most happy at this speed. This is remarkably high for a running-in process, and many engines would have probably been ruined. The engine was carefully watched for signs of distress during the period, but none was evident then or during the subsequent tests.

This apparent liking for high revs. would lead one to think that this was altogether a high-revving unit, and that the maximum output would be found very high up in the scale. This was not so, and it was not necessary to reach 16,000 r.p.m. during the tests.

The original glowplug burned out during running in and another was fitted. The performance fell remarkably when a short-reach plug was substituted, but on fitting the correct long-reach plug, happiness was restored. This point should be noted by users, as it may account for a mysterious falling-off in power.

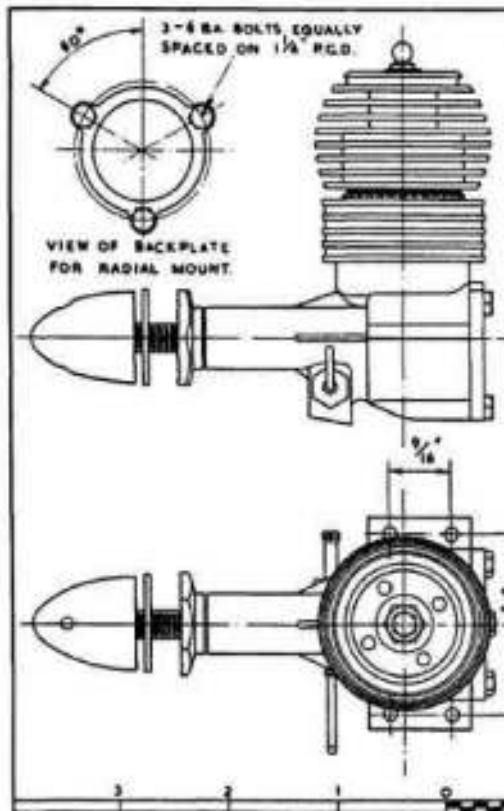

TEST

Engine: Yulon "49" (approx. 5 c.c.) Glowplug.

Fuel: Mercury No. 7 Glowplug.

Starting: Good under all conditions.

Running: Good at all tested speeds, especially around region of maximum b.h.p. output. Carburettor control was excellent and responsive, due to the needle valve giving a positive fuel cut-off when tightened down, and a gradual jet opening. This gradual opening made it necessary to act quickly at times when adjusting for correct running.

B.H.P.: As the graph shows, a very fine performance was obtained, with a maximum of 820 b.h.p. at 12,900 r.p.m. While the top of the curve is fairly flat—between 12,100 and 13,750 r.p.m.—a rather steep drop in output is seen on each side of these figures. Maximum output lies at a reasonable and convenient speed. The lowest figure recorded was 120 b.h.p. at around 5,000 r.p.m. From the curve it would seem that this would also be about the figure at 16,000 r.p.m.

Checked weight: 6.5 ozs. (less tank).

Power/Weight Ratio: 2.2 b.h.p./lb.

Remarks: The Yulon is a typical modern, high-performance engine, with the highest power/weight ratio yet recorded in these pages. It has been pointed out before that power/weight ratio is always in the favour of large engines and the high ratios which have been recorded for some smaller, high-efficiency units would lead one to expect very high figures for large engines of the same type. In addition, particular attention has been given in the Yulon design to weight-saving, resulting in a particularly clean and business-like appearance. The black crackle-finish enamel of the crankcase contrasts pleasingly with the polished alloy parts.

In practice, the power weight ratio would be considerably lessened by the fact that a rather large fuel tank would be necessary to give a reasonable duration of flight.

Recommended Aircrews:
Free flight: 11x5 ins.
Control line: Stunt, 10x6 ins. or 9x8 ins.
Speed: 8x12 ins. or 9x12 ins.

Bore: 0.960 ins.
Stroke: 0.687 ins.
Cylinder: Meehanite, Alloy retaining ring 40 T.P.I.
Cylinder Head: Low expansion alloy, screwed 40 T.P.I.
Crankcase: Die Cast, Anodised Black crackle finish.
Piston: Plain Meehanite, flat top.
Con-rod: Light Alloy, no bushings.
Crankshaft: 55 ton tensile, finished with Hard Chrome Deposit.

Main Bearing: Plain.
Crankshaft Valves: Rotary shaft inlet valve.
Special features: Duralumin crankshaft extension shaft is replaceable in the event of damage, has left hand thread. Threaded needle valve gives fine adjustment. Carburettor throat insert to improve carburettion.

GENERAL CONSTRUCTIONAL DATA

- Name: Yulon "49".
- Manufacturers: Yulon Engineering Co., 53, Woodland Road, Northfield, Birmingham 21.
- Retail Price: 99/6d.
- Type: Glowplug.
- Delivery: Ex-stock.
- Spares: Full spares and repair service at works.
- Specified Fuel: 37½% Dry Methanol, 27½% Nitro Methane, 25% Castor oil, Mercury No. 7 or Record Powerplus.
- Capacity: 6.2 c.c., 49 cu. ins.
- Weight (bare): 6½ ozs.
- Compression ratio: 8:1.
- Mounting: Beam or Radial.

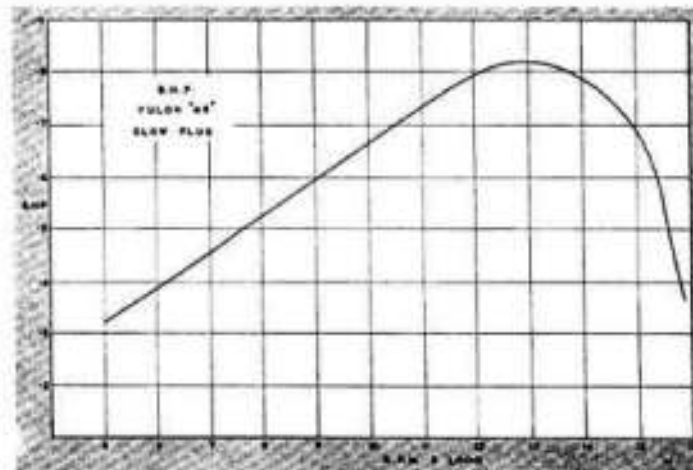

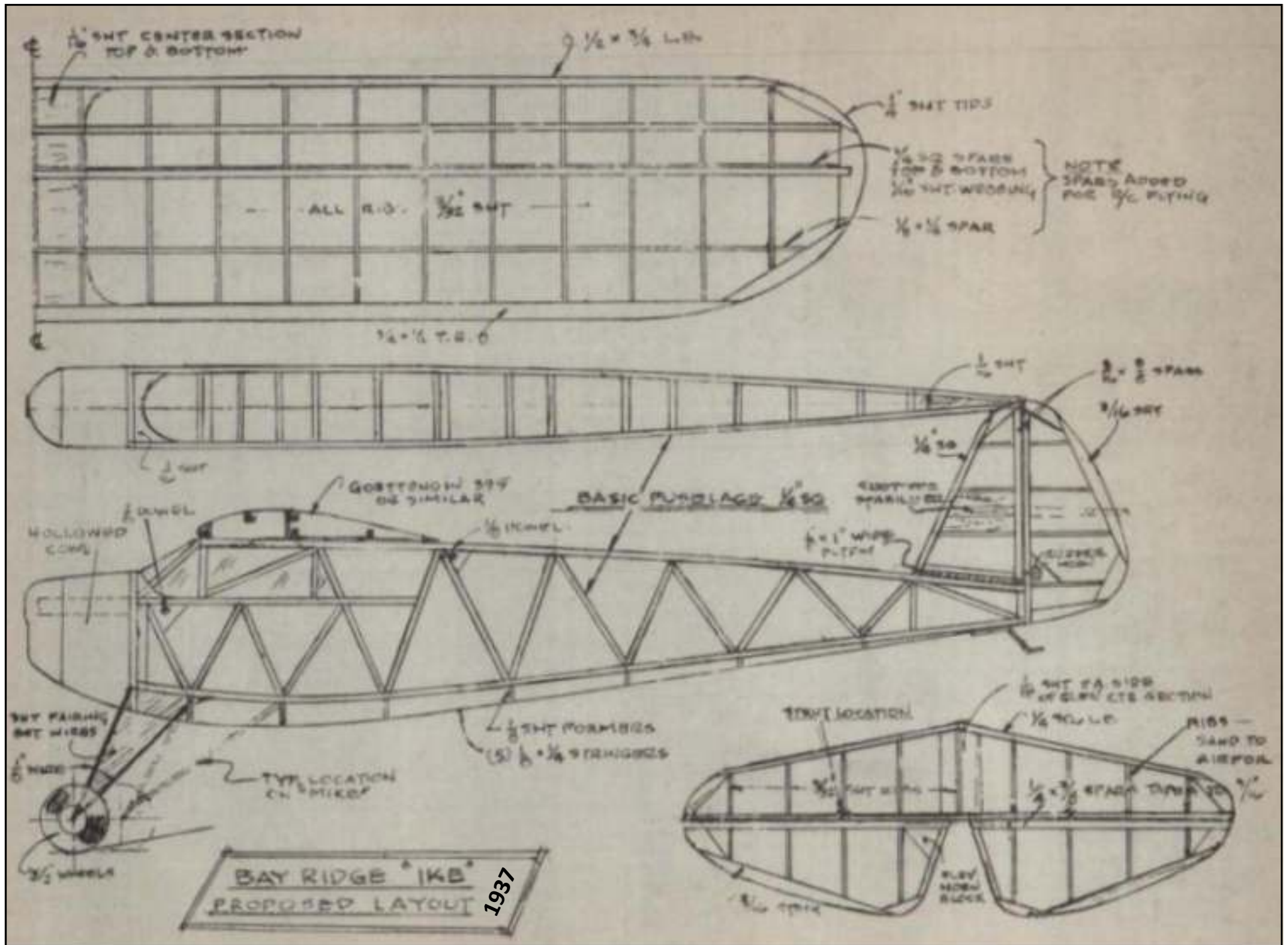

ENGINES - Arden .099

From Domenico Nick Bruschi.

The Arden engine was produced by Micro-Built Inc. Danbury Connecticut, based on an extreme project advanced mind having tolerances of less than 10 thousandths of an inch.

The engine must be treated carefully because it is a precision mechanism. If its use is done with right caution to attention the engine you are holding will have an extremely long life. Its power is equivalent roughly one horse per cubic inch of cubic capacity.

The engines were tested in the factory and tested to develop no less than 7200 rpm with 8X4 propeller for the model to be .099 and 10x5 for .199. However, full power cannot be obtained until after a few hours of running in.

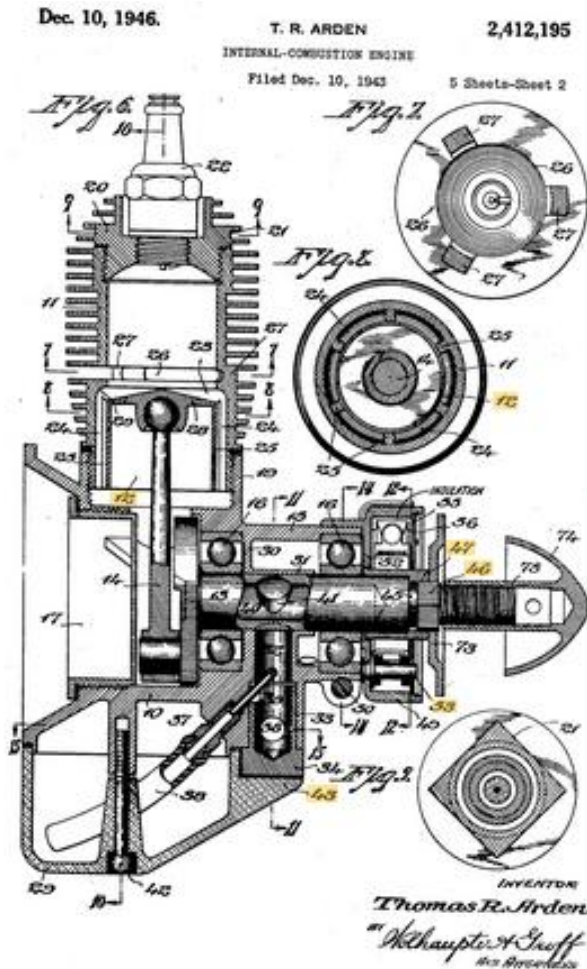

These engines reach maximum power between 10-11 thousand rpm. So you need to use the right helix that allow these tours. The motor must be firmly fixed to the motor castle and this must be fixed on a bench of work. A short spark plug should be used for the glow motor.

To start the engine, just close the air intake and turn the propeller a few times, connect the glow plug to the battery and give some quick blows to the propeller. When the engine has started, close the needle slowly until the engine warming up it turns regularly. Before launching the model, wait for the engine to turn regularly. If you encounter difficulties in ignition just put a few drops of mix-

ture through the exhaust with the piston in the lowest position. This may be necessary if the engine is "tight" due to deposits gummy oil. However, it is not necessary if the engine has been used recently. If the engine is flooded close the pin and turn the propeller a few times. When the engine is warmed up and running regularly it is advisable test the engine on the test bench before mounting it on the model. If, on the other hand, it is a used and stopped engine for some time it is better wash it, clean it and then grease it pretty well.

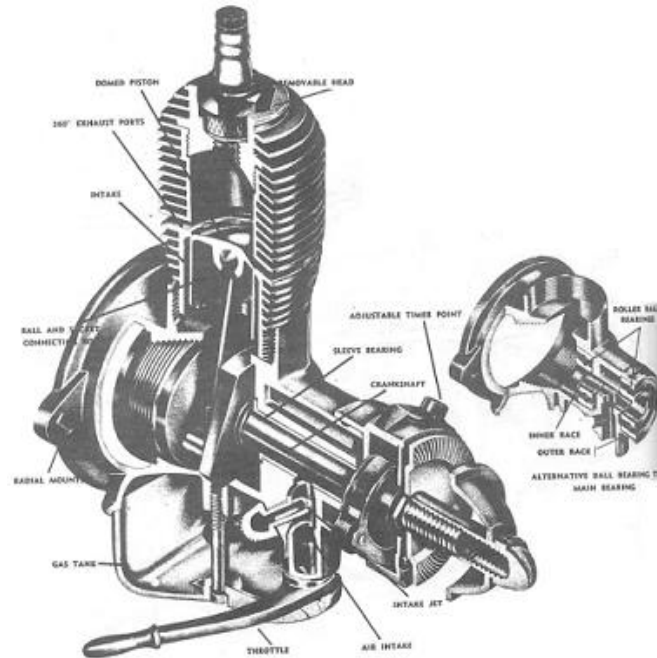

with deep cooling fins. The radial lights with the exhausts obtained by working the deep phalanges, the inputs of the mixture into the cylinder takes place between the shirt and the carter under the drains. The engine tests will be quite long in search of the better position of the carburetor needle. After several tests obtained this the engine will start without difficulty. However, the pin will remain very sensitive. There are also diesel conversions of the Arden engines, but the Diesel operation of these engines has proven too delicate for this use. Nowadays there is no shortage the right blends for Arden engines that will give users of these elegant engines a lot of satisfaction.



The Arden engines are direct descendants of the Atom engines produced in New York in the years 1940-1942. Those of Ray Arden saw the light in 1946, practically at the same time as the first glow candles produced by Ray Arden. As can be seen from the photos, these engines are very different from their brothers.

The construction is done using a delicate magnesium alloy and the cylinder using steel



A Practical Dispenser for CA Glue



Hypo needle

Does your super-glue always get hopelessly clogged? Do you have to cut back the tip every time you want to use it? Are you tired of caps that won't come off? Well here's a way to win the CA war once and for all!

The local drugstore is a good place to find hypodermic needles. You'll need a few small needles, about 22-gauge or so. Don't buy any plungers - just the needles.

Each needle comes with molded plastic part that fits to a hypodermic plunger by simply pushing it on. This will also fit to the tips of most CA bottles.

It may be necessary to trim the bottle tip back a bit to get a good, tight fit. With a file or a rotary tool, grind the point off the needle (they are dangerously sharp!) You now have a long and very tiny tip that will reach into small fuses, between stringers, etc. You can dispense very tiny droplets of CA this way.

What's that you say? The tip still clogs up?

Yes, but all you have to do is heat the tip with a lighter and it's wide open again! No caps, no pins, and no fiddling around. This method works every time, and takes the hassle out of thin CA glue.

Thanks to Denny Maize for the source of this tip.



Gorilla Fold-up Trestle from Bunnings

An interesting and practical modification of a "Gorilla" fold-up trestle from Bunnings by Stewart Clark from WRCS. Stewart disassembled the trestle (drilled out the pop rivets etc) and reduced its length. He used the surplus pieces and some extra square aluminium tube to make the tail-wheel rest. This slides in and out to suit the model. Model restraint poles were also added and covered in pipe lagging foam tube. A wooden rail is slipped into the trestle groove to make wheel chocks for the model. Holes are drilled in the bottom of the legs to allow pegging to the ground for larger models. The legs are height adjustable. The best part is that the whole thing folds up to a fairly small package for transport in the car. And it

can still be used as a trestle when painting the house! Good one Stewart!



A SIMPLE-TO-BUILD 8 inch DISC SANDER

Roy Bourke - MAAC 204 L - Toronto, Canada

For building model aircraft or for general-purpose shaping of wood or light metal, an 8" disc sander can be one of the most useful tools in the workshop. I built a simple disc sander over a weekend about 40 years ago and it has given me very faithful service ever since. And best of all it costs next to nothing to build one. Just find an old 1/4 hp. split phase or capacitor start motor with a 1/2" output shaft and you are more than half way to having a useful power tool that should last a lifetime.

I built my own disc, but cast aluminum discs that fit a 1/2" motor shaft are commercially available from many suppliers of machine tools. I chose 8" because you can either use ready-made adhesive-backed discs, or you can cut a disc from a standard 8 x 10" sheet of abrasive paper or cloth. The sander will easily handle any grit from about 50 to 320. I find grits of 80 to 100 to be the most useful for wood sanding.

Most 1/4 hp motors have a flat-based cradle to hold the motor, so it is necessary only to build a simple wooden base to bolt the motor cradle to, and to support a flat sanding table. I find the requirement to fit a table is so rare that it is not worth the trouble or complexity to build an adjustable tilting table. Also the table of commercial units often is made removable to facilitate changing abrasive discs. However, most 1/4 HP motors can easily be removed from their mounting cradle by removing two simple clamps, so I find it more convenient to simply remove the motor to change discs, and leave the table permanently screwed in place on the base.

I originally used 1" oak to make the base, but 3/4" or 1" plywood would work just as well. For the table I used 1/2" steel plate, but other materials such as Masonite, aluminum, Formica-covered board, etc. also could be used. Use whatever materials you have access to and can work with. The entire base and table could be built with standard woodworking tools.

I prefer to have the motor running clockwise (viewed from the front) for most work, but it is handy to be able to reverse the motor occasionally. This can be done by wiring a reversing switch into the starting winding circuit of a split phase motor. I found it simpler, for the few times that I needed to reverse the motor, to wire a switch in series with the centrifugal switch so I can disable the starting windings completely. Then I just spin the disc in the opposite direction before applying power to the motor, and it starts in the opposite direction (not exactly a CBA approved method, but it works!)

I have never found the adhesive-backed ready-made discs to stay stuck to the disc, so I always use disc cement.

There are a number of types on the market, but I have been using Titebond Franklin Disc Cement for several years now, with very good results. Lepages Pres-Tite Green Contact Cement (Canadian Tire, etc.) also works well.

The used discs can be removed more easily by using lacquer thinner or acetone to soften the cement.

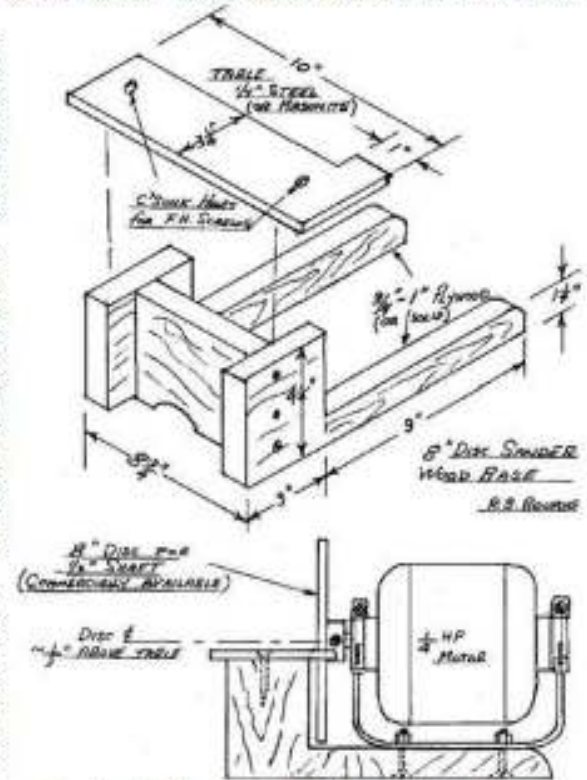

J. L. SADLER'S PACEMAKER

OLD TIMER Model of the Month

Plans redrawn by Phil Bernhardt

● Until J. L. Sadler came along with his Pacemaker (not related to the high wing cabin model of the same name by Irwin Ohlsson), low wing models were considered strictly taboo. However, with a combination of low thrust line, small vertical stabilizer, and generous dihedral . . . plus good looks, the Pacemaker, published in the January 1940 issue of *Air Trails*, proved that it could be done.

But it was only an interlude. Low wing, free flying models never made it in competition until Ed Kazmirski's famous R/C Orion came along . . . and by then, nobody wanted too much stability anyhow . . . it interfered with the piloting of model aircraft that were beginning to depend on electronics, not stability, to keep them in the air. ●



This picture is a repeat from our Feb. 1974 issue, but the only one we could find of a Pacemaker Built by John Haggart, of England, the wing has beautiful form, as this photo proves.

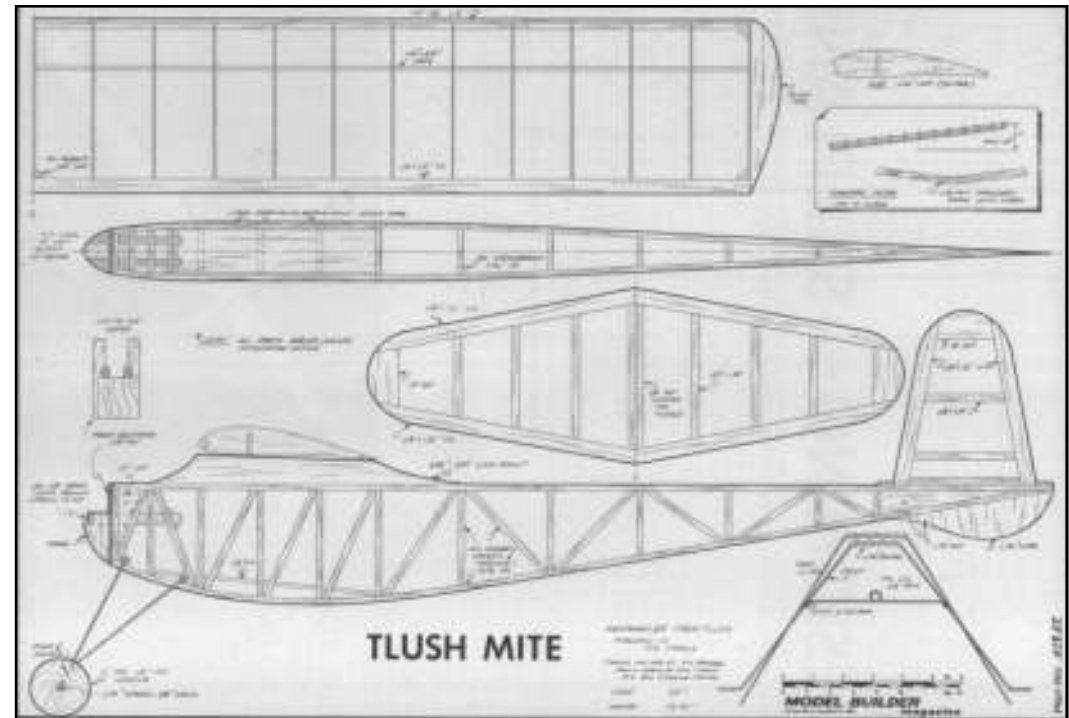
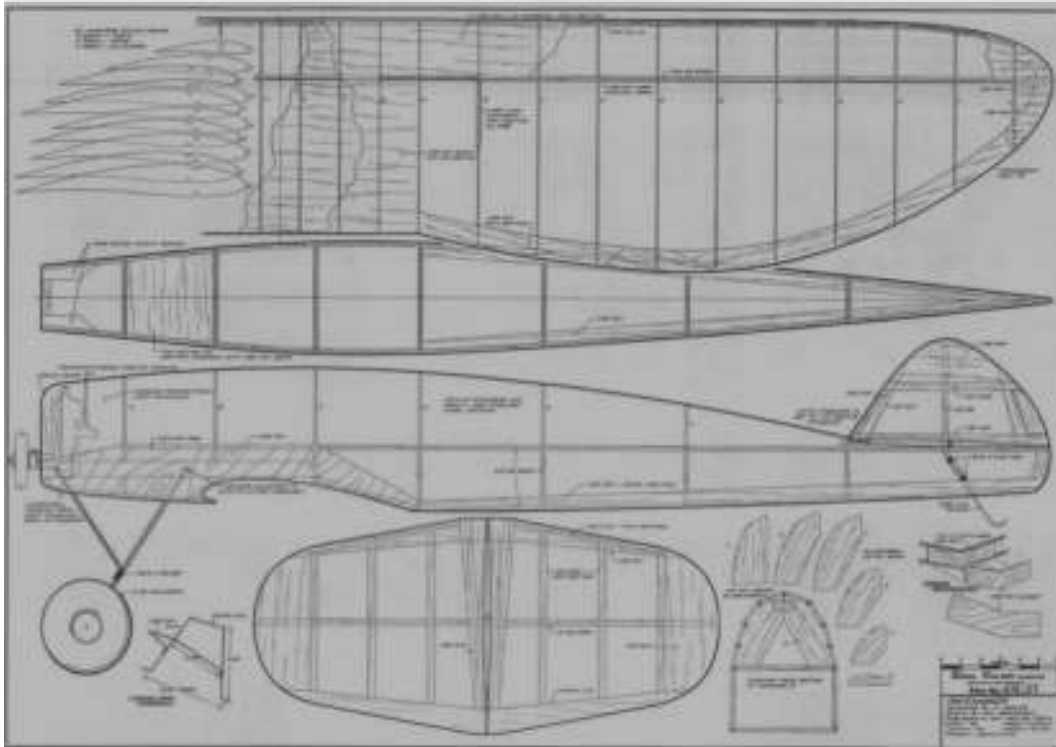

Outerzone PDF Plan: https://outerzone.co.uk/plan_details.asp?ID=6146

OLD TIMER Model of the Month

Designed by: Francis Tlush

Drawn by: Al Patterson

Text by: Bill Northrop

TLUSH "MITE"



● The cover painting in the May 1938 issue of *Air Trails* shows a Lockheed Electra XC-35 in U.S. Army colors. The cover story, also by artist Frank Tinsley, tells of the experiments being conducted at Wright Field by the Air Corps, attempting to solve the problems related to flying passengers above 15,000 feet, in pressurized cabins . . . something we all simply take for granted these days.

Back in the model section of the magazine, we find plans and a construction article by Francis Tlush entitled, "The Midget-Powered Mite". Tucked in the pages with the article is a yellowed piece of paper containing a price list of the materials to build the model. The material, as we priced it out back in 1938, came to \$1.69, without the Austin timer, which was an additional \$1.25! According to the list, we must have covered the fuselage with blue bamboo paper, and the flying surfaces with yellow tissue.

Oh yes, we built the model, modified (don't we all?) the wing from V to polyhedral, and installed an Atom engine. Being our second ever gas model (first was Bassett's "Miss Philly" with Baby Cyclone), the Mite spent much of its air time in cautious test glides. The greatest were down the gradual slope on a part of the nearby University of Delaware campus. Powered flights were definitely of the sport variety, nothing sensational, but consistent and very stable. The Atom engine was a jewel. It started easily on the pen cell flight

batteries . . . no boosters needed, and was easy to maintain. The retail price was \$12.50, and the cash was accumulated from lawn mowing and caddying at the local golf course.

The Mite would make a nice same-scale model for 2-minute precision competition, and based on the 225 sq. in./10 cu. in. displacement rule, it should really perform with an .09 engine, although a hot .049 would be adequate.

Wish we had a photo of our original so we could put in the polyhedral. . . ●

AUSTRALIA'S DWINDLING WATER RESERVES



To get some idea of Australia's dire water situation here is a picture from the Lake Hume dam wall during the 2007 MAAA Nats.

When full the water comes to the top of the foreground. The lake was 3% capacity in this photo. People can be seen at the edge of the water.

This is one of Australia's larger dams. At the time of this photo it was still draining to keep the Murry River flowing but it was expected to be empty towards the end of 2007.

When empty it had been proposed to ex-



cavate the dam's bed down 100 metres over many square kilometres for more storage capacity without increasing the surface area thus reducing evaporation.

It would be interesting to know where the proposers plan to put all that dirt!

The capacity at present is around 20% after recent rain.

RealClimate.org posted about the work of Dr. Ewe Noh-Watt of the New Zealand Institute of Veterinary Climatology, who had discovered that global warming was caused not by a build-up of carbon dioxide in the atmosphere, but rather by the decline of New Zealand's sheep population.

The reasoning was that sheep are white, and therefore large numbers of sheep increase the planet's albedo (the amount of sunlight reflected back into space). As the sheep population declined, the ground was absorbing more solar radiation, thus warming the planet: "It can be seen that the recent warming can be explained entirely by the decline in the New Zealand sheep population, without any need to bring in any mysterious so-called 'radiative forcing' from carbon dioxide, which doesn't affect the sunlight (hardly) anyway - unlike Sheep Albedo."

Noh-Watt also warned of a potentially destabilizing feedback mechanism: "As climate gets warmer, there is less demand for wool sweaters and woollen underwear. Hence the sheep population tends to drop, leading to even more warming. In an extreme form, this can lead to a 'runaway sheep-albedo feed-back,' which is believed to have led to the present torrid climate of Venus."



What a great photo, I didn't even see the 737 at first glance. And the Airbus is further away!! How is this for a size comparison? Somewhat startling. This shows an Airbus A380 and a Boeing B737 flying parallel approaches into LAX (Los Angeles, California)

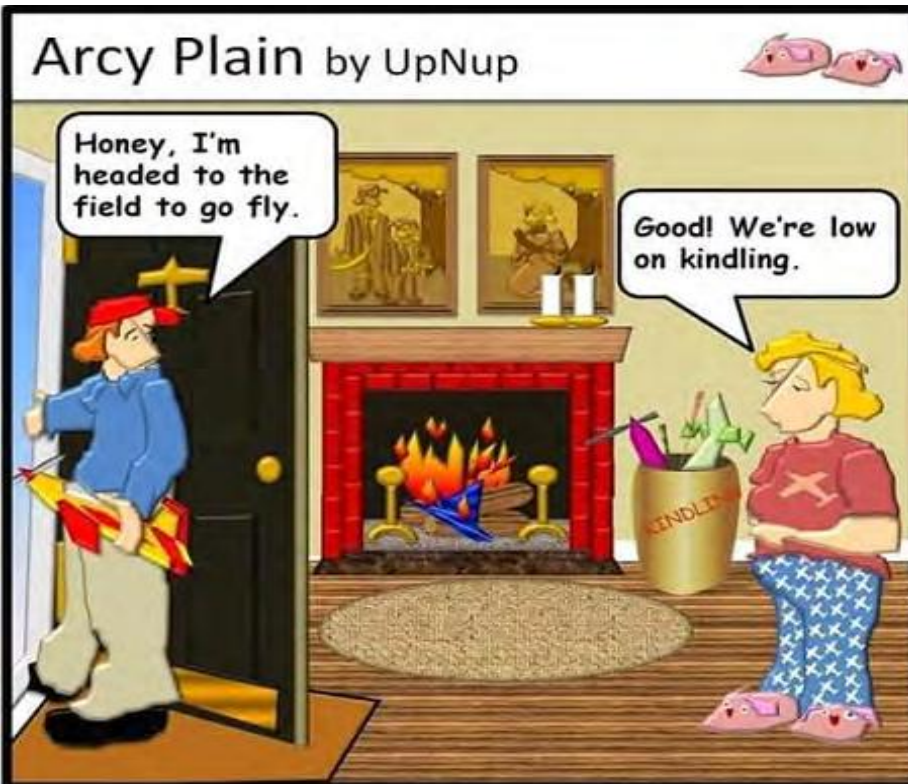

The Italian Secret to a Long Marriage.

At St. Peter's Catholic Church in Adelaide, they have weekly husbands' Marriage Seminars.

At the session, last week, the priest asked Chef Giuseppe, who said he was approaching his 50th wedding anniversary, to take a few minutes and share some insight into how he had managed to stay married to the same woman all these years.

Chef Giuseppe replied to the assembled husbands, 'Wella, I'va tried to treat her nicea, spenda da money on her, but besta of all is, I tooka her to Italy for the 25th anniver-sary!'

The priest responded, 'Giuseppe, you are an amazing inspiration to all the husbands here! Please tell us what you are planning for your wife for your 50th anniversary?'

Giuseppe proudly replied, "I gonna go pick her up."



TRIVIA	
Early 747 Airliners had what luxury in the First Class Cabin?	
On-Demand Video	A Piano Bar
Live News Reports	Hot Lather Shaves
Answer →	

Answer: A Piano Bar

If you're looking back from the 21st century at the way airline travel was romanticized in the mid-20th century, it would be easy to think it was only romanticized because it was new and the idea of getting on a jet and shooting across the ocean was a new and unique experience.

While the golden age of air travel was certainly such because it was the first time people could travel so quickly around the world, there's more to it.

Early air travel was downright luxurious compared to modern air travel. There were no overhead bins for carry-on luggage (because all luggage was checked at the gate or the door of the plane), so there was tons of head room. Seats were more amply sized. In-flight meals (real meals, not Diet Coke and pretzels) were common and in First Class, they were restaurant worthy.

The real mark of the golden age of air travel, however, was found in the upper deck of Boeing's iconic 747 airliner.

There you would find a space that hailed from the age of rail travel and luxurious dining cars. Couches, cocktails, and, on the early 747s, you'd even find a piano bar. Live entertainment above the clouds is something nearly unimaginable to the modern traveller and shows you just how much air travel has changed in the last half century.



Engine History in the Making (2014)

Say hello to the new Continental Motors Group, the world's first global producer of piston aircraft engines.

"Think globally, act locally." That's the business mantra of the newly formed Continental Motors Group, the world's first and only truly global producer of piston aircraft engines. What does it mean to you? Well, a few things actually. And they're all pretty important.

First, Continental Motors, founded in 1929, is suddenly a part of a much larger entity with major manufacturing centers in the United States, Europe and China after China's AVIC International acquired Continental in Mobile, Alabama, as well as Thielert in Germany, now known as Technify Motors. Development of gasoline piston en-

gines is slowly taking a backseat to diesel power, the centerpiece of which is the Centurion 2.0, built in Germany. It won't be Continental's last diesel, either.

You might not be aware of this bit of aviation trivia, but more than 4,000 Centurion diesel aircraft engines have been delivered since production began, originally under Thielert in 2002. Cumulatively they have flown 4 million flight hours. Not only are these jet-A-burning Centurion diesels extremely fuel efficient, they're also reliable. The in-flight shut down rate per 100,000 hours of the Centurion 2.0 over the last year, for example, has been just 0.61, far better than aviation gasoline engines on the whole and a big improvement over the original Thielert diesels. We can now safely say the Continental/Centurion diesel is pretty much bulletproof.

As we reported in today's eNews, Piper has announced a diesel version of the Archer to be called the DX model. Targeted primarily to European flight schools, several Centurion-powered Archers are expected to be sold in the United States once deliveries begin next year. Redbird and Premier Aircraft Sales, meanwhile, have announced diesel STC upgrades for gasoline-powered Cessna Skyhawks using the Centurion engine. It's only a matter of time before more such announcements are made.

But probably the biggest development to come from the creation of the global Continental Motors Group is what the Hong Kong-based entity is planning in China. Consider the statement made by Tian Shan, the new president of Continental Motors Beijing, as she offered up a bold prediction today at the start of Aero Friedrichshafen in Germany about the future of GA in her country. "AVIC is committed to the global market, but has a special place and obligation to bring general aviation products to China," she said. "Today, we see true growth opportunity in China, with the final comprehensive opening of nationwide, low-altitude airspace expected in 2015.

The huge potential for civil and business flights will soon lead to an increasing number of aircraft in service. As a gasoline and diesel engine manufacturer, maintenance and training service supplier, we are prepared for this historic opportunity."

It's just another example of how the new Continental Motors Group is thinking globally and acting locally - all while writing aviation history.



Centurion 2.0 diesel engine

THE BACK PAGE



S-m-o-o-t-h! The performance of the Ford V-8. It is brother-under-the-hood to the finest power plants—on land, on water and in the air. . . . Climb in, spin the prop, give it the gun and any open road is an invitation to a non-stop flight.



Paddy and Murphy are hammering floorboards down in a house. Paddy picks up a nail, realises it's upside down and throws it away. He carries on doing this until Murphy says, "Why are you throwing them away?"

"Because they're upside down," says Paddy.

"You daft prat," replies Murphy, "Save 'em for the ceiling!!"

